

Adapters/Couplings

Parker Autoclave Engineers offers a complete line of standard adapters and couplings as well as special designs and materials.

Male/Female Adapters:

Male/female adapters are designed to join a female connection directly to another size and/or type of connection without the need for an additional coupling.

Couplings:

Couplings and reducer/adaptor couplings accommodate female-to-female joining of any combination of standard size tubing listed.

Male/Male Adapters:

Male-to-male one piece adapters are designed to join two female connections of any combination listed.

QSS Male/Female Adapters:

Male/female adapters are designed to join a female connection directly to another size and/or type of connection without the need for an additional coupling.

QSS Male/Male Adapters:

Male-to-male one piece adapters are designed to join two female connections of any combination listed.

Male/Male JIC Adapters:

Male-to-male one piece adapters have one end machined with a 37° flare design.

Male/Female JIC Adapters:

Male/female adapters are designed to join a female connection directly to another size and/or type of connection without the need for an additional coupling.

EZ-Union Adapters:

O-ring face seal adapter.

Flat face style o-ring seal permits easy installation or removal of components.

Butt-Weld/Header Coupling Adapters:

Female to male adapters have one end machined for butt-welding to pipe, tubes, and headers.

Bulkhead Adapters:

Male to female adapters designed for panel mounting.

SAE O-Ring Adapters:

Female to male SAE/MS straight thread o-ring seal adapter.



For specials or other adapters not listed contact your local Sales Representative.



**Autoclave
Engineers** 
www.autoclave.com

Adapters/Couplings - Male/Female Adapters

Male /female adapters are designed to adapt a female connection to another size and/or type of connection without the need for additional couplings. In selecting an adapter involving two different sized connections, the larger connection should be on the male end where it is possible to maximize the mechanical strength of the adapter.

To use this chart:

1. Locate MALE end in vertical column.
2. Locate desired FEMALE end of adapter across top of chart.
3. Catalog number of required adapter is located at intersection of columns.
4. For one piece adapter add-OP to suffix of part number

Other Adapters

Parker Autoclave Engineers supplies many other types of adapters on special order. These include socketweld to O.D. tube or nominal pipe size, extended or special designs.

Materials

All Parker Autoclave Engineers adapters are precision machined from cold-worked Type 316 stainless steel. Other materials available on special order.

Note: Special material couplings may be supplied with four flats in place of standard hex. Pipe connections are rated 400°F (204°C) to -423°F (-17.8°C).

Connection Size and Type		SpeedBite				Medium Pressure						
		1/8" W125	1/4" SW250	3/8" SW375	1/2" SW500	1/4" SF250CX	3/8" SF375CX	9/16" SF562CX	3/4" SF750CX	1" SF1000CX	1-1/2" SF1500CX	
MALE END	SpeedBite	Fits this Female Connection	15,000 (1034.20)	15,000 (1034.20)	15,000 (1034.20)	10,000 (689.45)	20,000 (1378.93)	20,000 (1378.93)	20,000 (1378.93)	20,000 (1378.93)	20,000 (1378.93)	15,000 (1034.20)
		Pressure Rating PSI (bar)*	15,000 (1034.20)	15,000 (1034.20)	15,000 (1034.20)	10,000 (689.45)	20,000 (1378.93)	20,000 (1378.93)	20,000 (1378.93)	20,000 (1378.93)	20,000 (1378.93)	15,000 (1034.20)
		1/8" W125		6M24C2	6M26C2	4M28C2	6M24C6	6M26C6	6M29C6			15M224C6
	Medium Pressure	1/4" SW250	6M42D1		6M46D2	4M48D2	6M44D6	6M46D6	6M49D6	6M412D6		
		3/8" SW375	6M62D1	6M64D2		4M68D2	6M64D6	6M66D6	6M69D6	6M612D6	6M616D6	15M624D6
		1/2" SW500	4M82D1	4M84D2	4M86D2		4M84D6	4M86D6	4M89D6	4M812D6	4M816D6	
	High Pressure	1/4" SF250CX	15MX42K1	6MX44K2	6MX46K2	4MX48K2	20M44K6	20M46K6	20M49K6	20M412K6	20M416K6	
		3/8" SF375CX	15MX62K1	6MX64K2	6MX66K2	4MX68K2	20M64K6	20M66K6	20M69K6	20M612K6	20M616K6	
		9/16" SF562CX	15MX92K1	6MX94K2	6MX96K2	4MX98K2	20M94K6	20M96K6	20M99K6	20M912K6	20M916K6	
		3/4" SF750CX	15MX122K1	6MX124K2	6MX126K2	4MX128K2	20M124K6	20M126K6	20M129K6	20M1212K6	20M1216K6	
		1" SF1000CX	15MX162K1	6MX164K2	6MX166K2	4MX168K2	20M164K6	20M166K6	20M169K6	20M1612K6	20M1616K6	
		1-1/2" SF1500CX					15M244K6		15M249K6	15M2412K6	15M2416K6	
Flat Top Flat Bottom	1" F1000C43											
	1/4" F250C	15M42B1	6M44B2	6M46B2	4M48B2	20M44B6	20M46B6	20M49B6	20M412B6			
	5/16" F312C150		6M54B2	6M56B2	4M58B2	20M54B6	20M56B6	20M59B6	20M512B6			
	3/8" F375C	15M62B1	6M64B2	6M66B2	4M68B2	20M64B6	20M66B6	20M69B6	20M612B6	20M616B6		
	9/16" F562C	15M92B1	6M94B2	6M94B2	4M98B2	20M94B6	20M96B6	20M99B6	20M912B6	20M916B6		
	9/16" F562C40		6M94G2						20M912G6			
National Pipe Thread (NPT)	7/16" F437FB	15M72E1	6M74E2	6M76E2	4M78E2	15M74E6	15M76E6	15M79E6				
	9/16" F562FB	15M92E1	6M94E2	6M96E2	4M98E2	15M94E6	15M96E6	15M99E6	15M912E6	15M916E6		
	9/16" F562FT	15M92R1	6M94R2	6M96R2	4M98R2	15M94R6	15M96R6	15M99R6	15M912R6	15M916R6		
	3/4" F750FB	15M122E1	6M124E2	6M126E2	4M128E2	15M124E6	15M126E6	15M129E6	15M1212E6	15M1216E6		
	1/8" NPT	15M22N1	15M24N2	15M26N2	10M28N2	15M24N6	15M26N6	15M29N6				
1/4" NPT	15M42N1	15M44N2	15M46N2	10M48N2	15M44N6	15M46N6	15M49N6	15M412N6	15M416N6	15M424N6		
3/8" NPT	15M62N1	15M64N2	15M66N2	10M68N2	15M64N6	15M66N6	15M69N6	15M612N6	15M616N6			
1/2" NPT	15M82N1	15M84N2	15M86N2	10M88N2	15M84N6	15M86N6	15M89N6	15M812N6	15M816N6			
3/4" NPT		10M124N2	10M126N2	10M128N2	10M124N6	10M126N6	10M129N6	10M1212N6	10M1216N6			
1" NPT			10M166N2	10M168N2		10M166N6	10M169N6	10M1612N6	10M1616N6			

Note: All Parker Autoclave Engineers adapters are supplied complete with appropriate glands, collars, tube nuts and sleeves unless specified without.

* The maximum pressure rating for an adapter is determined by the connection component with the LOWEST pressure rating; that is, the two end connections and the tubing or pipe used, whichever is LOWER.

CAUTION: See appropriate pressure section in reference to proper selection of tubing.

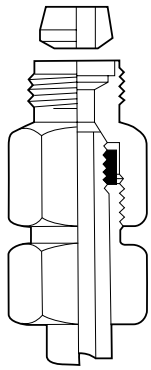

Double Cone Plug
(Medium Pressure shown)

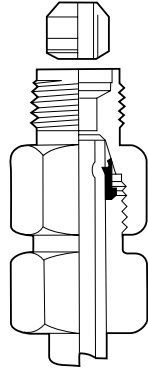

Double Cone Plug
(SpeedBite shown)

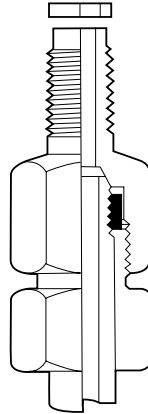

Flat Bottom Gasket
(Medium Pressure shown)

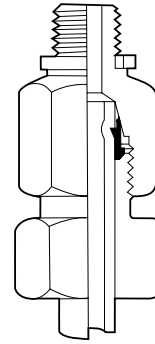

Flat Top Gasket
(SpeedBite shown)

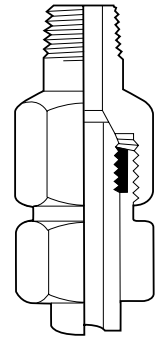

Male NPT
(High Pressure shown)

FEMALE END

High Pressure						National Pipe Thread (NPT)					
1" F1000C43	1/4" F250C	5/16" F312C150	3/8" F375C	9/16" F562C	9/16" F562C40	1/8" NPT	1/4" NPT	3/8" NPT	1/2" NPT	3/4" NPT	1" NPT
43,000 (2964.69)	60,000 (4136.85)	150,000 (10342.14)	60,000 (4136.85)	60,000 (4136.85)	40,000 (2757.90)	15,000 (1034.20)	15,000 (1034.20)	15,000 (1034.20)	15,000 (1034.20)	10,000 (689.45)	10,000 (689.45)
	6M24C3		6M26C3	6M29C3		15M22C8	15M24C8	15M26C8	15M28C8		
	6M44D3		6M46D3	6M49D3		15M42D8	15M44D8	15M46D8	15M48D8	10M412D8	
	6M64D3		6M66D3	6M69D3		15M62D8	15M64D8	15M66D8	15M68D8	10M612D8	10M616D8
	4M84D3		4M86D3	4M89D3		10M82D8	10M84D8	10M86D8	10M88D8	10M812D8	10M816D8
	20M44K3	20M45K3	20M46K3	20M49K3		15MX42K8	15MX44K8	15MX46K8	15MX48K8	10MX412K8	
	20M64K3	20M65K3	20M66K3	20M69K3		15MX62K8	15MX64K8	15MX66K8	15MX68K8	10MX612K8	10MX616K8
	20M94K3	20M95K3	20M96K3	20M99K3		15MX92K8	15MX94K8	15MX96K8	15MX98K8	10MX912K8	10MX916K8
20M1216K3	20M124K3	20M125K3	20M126K3	20M129K3	20M129K40		15MX124K8	15MX126K8	15MX128K8	10MX1212K8	10MX1216K8
	20M164K3		20M166K3	20M169K3			15MX164K8	15MX166K8	15MX168K8	10MX1612K8	10MX1616K8
							15M244K8		15M248K8		
	43M164B3		43M166B3	43M169B3	43M169B40						
43M416B3	60M44B3	60M45B3	60M46B3	60M49B3		15M42B8	15M44B8	15M46B8	15M48B8	10M412B8	10M416B8
	60M54B3		60M56B3	60M59B3					15M58B8	10M512B8	
43M616B3	60M64B3	60M65B3	60M66B3	60M69B3		15M62B8	15M64B8	15M66B8	15M68B8	10M612B8	10M616B8
43M916B3	60M94B3	60M95B3	60M96B3	60M99B3		15M92B8	15M94B8	15M96B8	15M98B8	10M912B8	10M916B8
									15M98G8		
	15M74E3		15M76E3	15M79E3		10M72E8	10M74E8	10M76E8	10M78E8	10M712E8	
	15M94E3		15M96E3			10M92E8	10M94E8	10M96E8	10M98E8	10M912E8	10M916E8
	15M94R3		15M96R3	15M99R3		10M92R8	10M94R8	10M96R8	10M98R8	10M912R8	10M916R8
	15M124E3		15M126E3	15M129E3		10M122E8	10M124E8	10M126E8	10M128E8	10M1212E8	10M1216E8
	15M24N3		15M26N3	15M29N3			15M24N8				
	15M44N3	15M45N3	15M46N3	15M49N3		15M42N8		15M46N8	15M48N8		
	15M64N3		15M66N3	15M69N3	15M69N40		15M64N8		15M68N8		
	15M84N3		15M86N3	15M89N3	15M89N40		15M84N8	15M86N8		10M812N8	
	10M124N3		10M126N3	10M129N3		10M122N8	10M124N8		10M128N8		
			10M166N3	10M169N3					10M168N8		

Parker Autoclave Engineers Male/Female Adapters are available in a "one-piece" design. They are identical to the two piece designs in length and can be ordered by adding the suffix - OP to the two piece adapter part numbers listed.

For prompt service, Parker Autoclave Engineers stocks select products. Consult factory.

Adapters/Couplings - Male/Female Adapters

Speed Bite

Male End Fits this Connection	Female End	Catalog Number	Dimension inches (mm)	
			A Hex	B
W125	W125			
W125	SW250	6M24C2	0.63 (15.9)	1.29 (32.1)
W125	SW375	6M26C2	0.75 (19.1)	1.41 (35.8)
W125	SW500	4M28C2	1.00 (25.4)	1.53 (38.8)
W125	SF250CX	6M24C6	0.63 (15.9)	1.41 (35.8)
W125	SF375CX	6M26C6	0.75 (19.1)	1.41 (35.8)
W125	SF562CX	6M29C6	1.00 (25.4)	1.66 (42.1)
W125	SF750CX			
W125	SF1000CX			
W125	SF1500CX	15M224C6	2.25 (57.15)	3.41 (86.54)
W125	F1000C43			
W125	F250C	6M24C3	0.75 (19.1)	1.16 (29.5)
W125	F312C150			
W125	F375C	6M26C3	1.00 (25.4)	1.34 (34.1)
W125	F562C	6M29C3	1.38 (35.1)	1.59 (40.5)
W125	F562C40			
W125	1/8 NPT	15M22C8	0.63 (15.9)	1.25 (31.8)
W125	1/4 NPT	15M24C8	0.75 (19.1)	1.47 (37.3)
W125	3/8 NPT	15M26C8	1.00 (25.4)	1.53 (38.8)
W125	1/2 NPT	15M28C8	1.18 (30.1)	1.81 (46.0)
W125	3/4 NPT			
W125	1 NPT			
SW250	W125	6M42D1	0.63 (15.9)	1.08 (27.4)
SW250	SW250			
SW250	SW375	6M46D2	0.75 (19.1)	1.64 (41.7)
SW250	SW500	4M48D2	1.00 (25.4)	1.77 (44.9)
SW250	SF250CX	6M44D6	0.63 (15.9)	1.52 (38.5)
SW250	SF375CX	6M46D6	0.75 (19.1)	1.77 (44.9)
SW250	SF562CX	6M49D6	1.00 (25.4)	1.89 (48.0)
SW250	SF750CX	6M412D6	1.38 (35.1)	2.27 (57.7)
SW250	SF1000CX			
SW250	F1000C43			
SW250	F250C	6M44D3	.75 (19.1)	1.27 (32.2)
SW250	F312C150			
SW250	F375C	6M46D3	1.00 (25.4)	1.70 (43.3)
SW250	F562C	6M49D3	1.38 (35.1)	1.77 (44.9)
SW250	F562C40			
SW250	1/8 NPT	15M42D8	0.63 (15.9)	1.39 (35.3)
SW250	1/4 NPT	15M44D8	0.75 (19.1)	1.64 (41.7)
SW250	3/8 NPT	15M46D8	1.00 (25.4)	1.70 (43.3)
SW250	1/2 NPT	15M48D8	1.18 (30.1)	1.95 (49.6)
SW250	3/4 NPT	10M412D8	1.38 (35.1)	2.21 (56.0)
SW250	1 NPT			

Male End Fits this Connection	Female End	Catalog Number	Dimension inches (mm)	
			A Hex	B
SW375	W125	6M62D1	0.75 (19.1)	1.16 (29.4)
SW375	SW250	6M64D2	0.75 (19.1)	1.41 (35.7)
SW375	SW375			
SW375	SW500	4M68D2	1.00 (25.4)	1.78 (45.3)
SW375	SF250CX	6M64D6	0.75 (19.1)	1.41 (35.9)
SW375	SF375CX	6M66D6	0.75 (19.1)	1.59 (40.4)
SW375	SF562CX	6M69D6	1.00 (25.4)	1.72 (43.7)
SW375	SF750CX	6M612D6	1.38 (35.1)	2.28 (57.9)
SW375	SF1000CX	6M616D6	1.75 (44.5)	2.78 (70.7)
SW375	SF1500CX	15M624D6	2.25 (57.15)	3.53 (89.71)
SW375	F1000C43			
SW375	F250C	6M64D3	0.75 (19.1)	1.41 (35.7)
SW375	F312C150			
SW375	F375C	6M66D3	1.00 (25.4)	1.66 (42.2)
SW375	F562C	6M69D3	1.38 (35.1)	1.78 (45.3)
SW375	F562C40			
SW375	1/8 NPT	15M62D8	0.75 (19.1)	1.41 (35.7)
SW375	1/4 NPT	15M64D8	0.75 (19.1)	1.66 (42.2)
SW375	3/8 NPT	15M66D8	1.00 (25.4)	1.78 (45.3)
SW375	1/2 NPT	15M68D8	1.18 (30.1)	1.97 (50.0)
SW375	3/4 NPT	10M612D8	1.38 (35.1)	2.28 (57.9)
SW375	1 NPT	10M616D8	1.75 (44.5)	2.78 (70.7)
SW500	W125	4M82D1	0.94 (23.8)	1.22 (31.0)
SW500	SW250	4M84D2	0.94 (23.8)	1.34 (34.1)
SW500	SW375	4M86D2	0.94 (23.8)	1.47 (37.3)
SW500	SW500			
SW500	SF250CX	4M84D6	1.00 (25.4)	1.59 (40.5)
SW500	SF375CX	4M86D6	1.00 (25.4)	1.59 (40.5)
SW500	SF562CX	4M89D6	1.00 (25.4)	1.66 (42.2)
SW500	SF750CX	4M812D6	1.38 (35.1)	2.09 (53.2)
SW500	SF1000CX	4M816D6	1.75 (44.5)	2.72 (69.0)
SW500	F1000C43			
SW500	F250C	4M84D3	0.94 (23.8)	1.41 (35.7)
SW500	F312C150			
SW500	F375C	4M86D3	1.00 (25.4)	1.59 (40.5)
SW500	F562C	4M89D3	1.38 (35.1)	1.72 (43.7)
SW500	F562C40			
SW500	1/8 NPT	10M82D8	1.00 (25.4)	1.34 (34.1)
SW500	1/4 NPT	10M84D8	1.00 (25.4)	1.47 (37.3)
SW500	3/8 NPT	10M86D8	1.00 (25.4)	1.72 (43.7)
SW500	1/2 NPT	10M88D8	1.18 (30.1)	2.16 (54.7)
SW500	3/4 NPT	10M812D8	1.38 (35.1)	2.22 (56.3)
SW500	1 NPT	10M816D8	1.75 (44.5)	2.47 (62.7)

Maximum pressure rating is based on the lowest rating of any component. Actual working pressure may be determined by tubing pressure rating, if lower.

Note: For pressure rating see selection chart.

All Dimensions for reference only and subject to change.

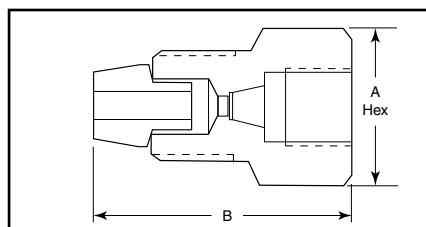

For prompt service, Parker Autoclaves Engineers stocks select products. Consult factory.

Medium Pressure

Male End Fits this Connection	Female End	Catalog Number	Dimension inches (mm)	
			A Hex	B
SF250CX	W125	15MX42K1	0.63 (15.9)	1.34 (34.1)
SF250CX	SW250	6MX44K2	0.63 (15.9)	1.59 (40.5)
SF250CX	SW375	6MX46K2	0.75 (19.1)	1.59 (40.5)
SF250CX	SW500	4MX48K2	1.00 (25.4)	1.00 (25.4)
SF250CX	SF250CX	20M44K6	0.63 (15.9)	1.47 (37.3)
SF250CX	SF375CX	20M46K6	0.75 (19.1)	1.59 (40.5)
SF250CX	SF562CX	20M49K6	1.00 (25.4)	1.97 (50.0)
SF250CX	SF750CX	20M412K6	1.38 (35.1)	2.34 (59.5)
SF250CX	SF1000CX	20M416K6	1.75 (44.5)	2.84 (72.2)
SF250CX	F1000C43			
SF250CX	F250C	20M44K3	0.75 (19.1)	1.28 (32.5)
SF250CX	F312C150	20M45K3	1.00 (25.4)	2.09 (53.2)
SF250CX	F375C	20M46K3	1.00 (25.4)	1.59 (40.5)
SF250CX	F562C	20M49K3	1.38 (35.1)	1.97 (50.0)
SF250CX	F562C40			
SF250CX	1/8 NPT	15MX42K8	0.63 (15.9)	1.47(37.3)
SF250CX	1/4 NPT	15MX44K8	0.75 (19.1)	1.59 (40.5)
SF250CX	3/8 NPT	15MX46K8	1.00 (25.4)	1.66 (42.2)
SF250CX	1/2 NPT	15MX48K8	1.18 (30.1)	1.97 (50.0)
SF250CX	3/4 NPT	10MX412K8	1.38 (35.1)	2.09 (53.2)
SF250CX	1 NPT			
SF375CX	W125	15MX62K1	0.63 (15.9)	1.50 (38.1)
SF375CX	SW250	6MX64K2	0.63 (15.9)	1.63 (41.3)
SF375CX	SW375	6MX66K2	1.00 (25.4)	1.82 (46.0)
SF375CX	SW500	4MX68K2	1.00 (25.4)	2.00 (50.8)
SF375CX	SF250CX	20M64K6	0.63 (15.9)	1.39 (35.2)
SF375CX	SF375CX	20M66K6	.75 (19.1)	1.66 (42.2)
SF375CX	SF562CX	20M69K6	1.00 (25.4)	2.06 (52.4)
SF375CX	SF750CX	20M612K6	1.38 (35.1)	2.50 (63.5)
SF375CX	SF1000CX	20M616K6	1.75 (44.5)	3.06 (77.8)
SF375CX	F1000C43			
SF375CX	F250C	20M64K3	0.75 (19.1)	1.44 (36.5)
SF375CX	F312C150	20M65K3	1.00 (25.4)	2.25 (57.2)
SF375CX	F375C	20M66K3	1.00 (25.4)	1.63 (41.3)
SF375CX	F562C	20M69K3	1.38 (35.1)	1.88 (47.6)
SF375CX	F562C40			
SF375CX	1/8 NPT	15MX62K8	0.63 (15.9)	1.75 (44.5)
SF375CX	1/4 NPT	15MX64K8	0.75 (19.1)	1.81 (46.0)
SF375CX	3/8 NPT	15MX66K8	1.00 (25.4)	1.88 (47.6)
SF375CX	1/2 NPT	15MX68K8	1.18 (30.1)	2.12 (54.0)
SF375CX	3/4 NPT	10MX612K8	1.38 (35.1)	2.38 (60.3)
SF375CX	1 NPT	10MX616K8	1.75 (44.5)	2.63 (66.7)

Male End Fits this Connection	Female End	Catalog Number	Dimension inches (mm)	
			A Hex	B
SF562CX	W125	15MX92K1	0.81 (20.6)	1.75 (44.5)
SF562CX	SW250	6MX94K2	0.94 (23.8)	1.75 (44.5)
SF562CX	SW375	6MX96K2	0.94 (23.8)	1.75 (44.5)
SF562CX	SW500	4MX98K2	1.00 (25.4)	1.94 (49.2)
SF562CX	SF250CX	20M94K6	0.94 (23.8)	1.34 (34.1)
SF562CX	SF375CX	20M96K6	0.94 (23.8)	1.34 (59.5)
SF562CX	SF562CX	20M99K6	1.00 (25.4)	2.00 (50.8)
SF562CX	SF750CX	20M912K6	1.38 (35.1)	3.12 (79.3)
SF562CX	SF1000CX	20M916K6	1.75 (44.5)	3.75 (95.3)
SF562CX	F1000C43			
SF562CX	F250C	20M94K3	0.81 (20.6)	1.81 (46.0)
SF562CX	F312C150	20M95K3	1.00 (25.4)	2.50 (63.5)
SF562CX	F375C	20M96K3	1.00 (25.4)	2.00 (50.8)
SF562CX	F562C	20M99K3	1.38 (35.1)	2.12 (54.0)
SF562CX	F562C40			
SF562CX	1/8 NPT	15MX92K8	0.94 (23.8)	1.75 (44.5)
SF562CX	1/4 NPT	15MX94K8	0.94 (23.8)	2.18 (55.5)
SF562CX	3/8 NPT	15MX96K8	0.94 (23.8)	2.18 (55.5)
SF562CX	1/2 NPT	15MX98K8	1.18 (30.1)	2.44 (61.9)
SF562CX	3/4 NPT	10MX912K8	1.50 (38.1)	2.50 (63.5)
SF562CX	1 NPT	10MX916K8	1.75 (44.5)	3.00 (76.2)
SF750CX	W125			
SF750CX	SW250	6MX124K2	1.18 (30.1)	2.06 (52.4)
SF750CX	SW375	6MX126K2	1.18 (30.1)	1.97 (50.0)
SF750CX	SW500	4MX128K2	1.18 (30.1)	2.32 (58.72)
SF750CX	SF250CX	20M124K6	1.18 (30.1)	2.06 (52.4)
SF750CX	SF375CX	20M126K6	1.18 (30.1)	2.06 (52.4)
SF750CX	SF562CX	20M129K6	1.18 (30.1)	1.69 (61.9)
SF750CX	SF750CX	20M1212K6	1.38 (35.1)	2.56 (65.0)
SF750CX	SF1000CX	20M1216K6	1.75 (44.5)	3.50 (88.9)
SF750CX	F1000C43	20M1216K3	1.75 (44.5)	3.063 (77.78)
SF750CX	F250C	20M124K3	1.18 (30.1)	2.06 (52.32)
SF750CX	F312C150	20M125K3	1.18 (30.1)	3.12 (79.3)
SF750CX	F375C	20M126K3	1.18 (30.1)	2.06 (52.4)
SF750CX	F562C	20M129K3	1.38 (35.1)	2.32 (58.93)
SF750CX	F562C40	20M129K40	1.38 (35.1)	2.38 (60.4)
SF750CX	1/8 NPT			
SF750CX	1/4 NPT	15MX124K8	1.18 (30.1)	2.50 (63.5)
SF750CX	3/8 NPT	15MX126K8	1.18 (30.1)	2.88 (73.0)
SF750CX	1/2 NPT	15MX128K8	1.18 (30.1)	2.88 (73.0)
SF750CX	3/4 NPT	10MX1212K8	1.38 (35.1)	3.12 (79.3)
SF750CX	1 NPT	10MX1216K8	1.75 (44.5)	3.50 (88.9)

Maximum pressure rating is based on the lowest rating of any component. Actual working pressure may be determined by tubing pressure rating, if lower.

Note: For pressure rating see selection chart.

All Dimensions for reference only and subject to change.

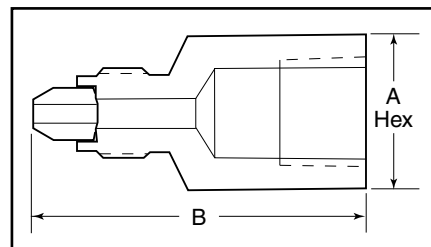

Adapter configurations may vary from outline shown

For prompt service, Parker Autoclave Engineers stocks select products. Consult factory.

Male End Fits this Connection	Female End	Catalog Number	Dimension inches (mm)	
			A Hex	B
SF1000CX	W125	6MX162K2	1.38 (35.1)	2.69 (68.3)
SF1000CX	SW250	6MX164K2	1.38 (35.1)	2.63 (66.7)
SF1000CX	SW375	6MX166K2	1.38 (35.1)	2.63 (66.7)
SF1000CX	SW500	4MX168K2	1.18 (30.1)	2.69 (68.25)
SF1000CX	SF250CX	20M164K6	1.38 (35.1)	2.63 (66.7)
SF1000CX	SF375CX	20M166K6	1.38 (35.1)	2.63 (66.7)
SF1000CX	SF562CX	20M169K6	1.38 (35.1)	2.63 (66.7)
SF1000CX	SF750CX	20M1612K6	1.50 (38.1)	2.12 (54.0)
SF1000CX	SF1000CX			
SF1000CX	F1000C43			
SF1000CX	F250C	20M164K3	1.38 (35.1)	2.18 (55.6)
SF1000CX	F312C150			
SF1000CX	F375C	20M166K3	1.38 (35.1)	2.18 (55.6)
SF1000CX	F562C	20M169K3	1.50 (38.1)	2.44 (61.9)
SF1000CX	F562C40			
SF1000CX	1/8 NPT			
SF1000CX	1/4 NPT	15MX164K8	1.50 (38.1)	3.18 (81.0)
SF1000CX	3/8 NPT	15MX166K8	1.75 (44.5)	3.18 (81.0)
SF1000CX	1/2 NPT	15MX168K8	1.75 (44.5)	3.18 (81.0)
SF1000CX	3/4 NPT	10MX1612K8	1.75 (44.5)	3.18 (81.0)
SF1000CX	1 NPT	10MX1616K8	1.75 (44.5)	3.18 (81.0)

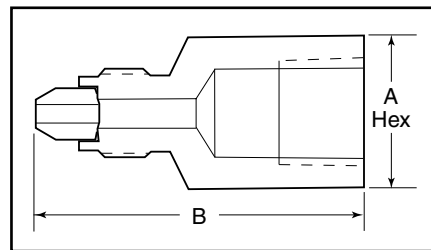

Adapter configurations may vary from outline shown

Male End Fits this Connection	Female End	Catalog Number	Dimension inches (mm)	
			A Hex	B
SF1500CX	SF250CX	15M244K6	1.88 (47.75)	3.31 (84.12)
SF1500CX	SF562CX	15M249K6	1.88 (47.75)	3.31 (84.12)
SF1500CX	SF750CX	15M2412K6	1.88 (47.75)	3.81 (96.82)
SF1500CX	SF1000CX	15M2416K6	1.88 (47.75)	4.06 (103.17)
SF1500CX	1/4 NPT	15M244K8	1.75 (44.5)	3.56 (90.43)
SF1500CX	1/2 NPT	15M248K8	1.75 (44.5)	3.56 (90.43)

High Pressure

Male End Fits this Connection	Female End	Catalog Number	Dimension inches (mm)	
			A Hex	B
F1000C43	W125			
F1000C43	SW250			
F1000C43	SW375			
F1000C43	SW500			
F1000C43	SF250CX			
F1000C43	SF375CX			
F1000C43	SF562CX			
F1000C43	SF750CX			
F1000C43	SF1000CX			
F1000C43	F1000C43			
F1000C43	F250C	43M164B3	1.38 (35.1)	2.31 (58.7)
F1000C43	F312C150			
F1000C43	F375C	43M166B3	1.38 (35.1)	2.31 (58.7)
F1000C43	F562C	43M169B3	1.50 (38.1)	2.56 (65.1)
F1000C43	F562C40	43M169B40	1.50 (38.1)	2.56 (65.1)
F1000C43	1/8 NPT			
F1000C43	1/4 NPT			
F1000C43	3/8 NPT			
F1000C43	1/2 NPT			
F1000C43	3/4 NPT			
F1000C43	1 NPT			

Male End Fits this Connection	Female End	Catalog Number	Dimension inches (mm)	
			A Hex	B
F250C	W125	15M42B1	0.63 (15.9)	1.25 (31.7)
F250C	SW250	6M44B2	0.63 (15.9)	1.44 (36.5)
F250C	SW375	6M46B2	0.75 (19.1)	1.56 (39.7)
F250C	SW500	4M48B2	1.00 (25.4)	1.69 (42.8)
F250C	SF250CX	20M44B6	0.63 (15.9)	1.31 (33.3)
F250C	SF375CX	20M46B6	0.75 (19.1)	1.69 (42.8)
F250C	SF562CX	20M49B6	1.00 (25.4)	1.81 (46.0)
F250C	SF750CX	20M412B6	1.38 (35.1)	2.18 (55.5)
F250C	SF1000CX			
F250C	F1000C43	43M416B3	1.75 (44.5)	3.00 (76.2)
F250C	F250C	60M44B3	0.81 (20.6)	1.38 (35.1)
F250C	F312C150	60M45B3	1.00 (25.4)	2.06 (52.4)
F250C	F375C	60M46B3	1.00 (25.4)	1.56 (39.7)
F250C	F562C	60M49B3	1.38 (35.1)	1.81 (46.0)
F250C	F562C40			
F250C	1/8 NPT	15M42B8	0.63 (15.9)	1.38 (34.9)
F250C	1/4 NPT	15M44B8	0.75 (19.1)	1.69 (42.8)
F250C	3/8 NPT	15M46B8	1.00 (25.4)	1.69 (42.8)
F250C	1/2 NPT	15M48B8	1.18 (30.1)	2.00 (50.8)
F250C	3/4 NPT	10M412B8	1.38 (35.1)	2.18 (55.5)
F250C	1 NPT	10M416B8	1.75 (44.5)	2.38 (60.3)

Maximum pressure rating is based on the lowest rating of any component. Actual working pressure may be determined by tubing pressure rating, if lower.

Note: For pressure rating see selection chart.

All Dimensions for reference only and subject to change.

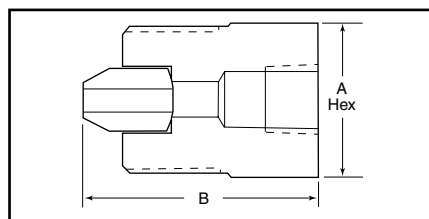

Note: Adapter configurations may vary from outline shown

For prompt service, Parker Autoclave Engineers stocks select products. Consult factory.

Male End Fits this Connection	Female End	Catalog Number	Dimension inches (mm)	
			A Hex	B
F312C150	W125			
F312C150	SW250	6M54B2	0.75 (19.1)	2.13 (54.0)
F312C150	SW375	6M56B2	0.75 (19.1)	2.25 (57.2)
F312C150	SW500	4M58B2	1.00 (25.4)	
F312C150	SF250CX	20M54B6	0.75 (19.1)	2.00 (50.8)
F312C150	SF375CX	20M56B6	0.75 (19.1)	2.25 (57.2)
F312C150	SF562CX	20M59B6	1.00 (25.4)	2.38 (60.4)
F312C150	SF750CX	20M512B6	1.38 (35.1)	3.00 (76.2)
F312C150	SF1000CX			
F312C150	F1000C43			
F312C150	F250C	60M54B3	1.00 (25.4)	2.06 (52.4)
F312C150	F312C150			
F312C150	F375C	60M56B3	1.00 (25.4)	2.25 (57.2)
F312C150	F562C	60M59B3	1.38 (35.1)	2.56 (65.1)
F312C150	F562C40			
F312C150	1/8 NPT			
F312C150	1/4 NPT			
F312C150	3/8 NPT			
F312C150	1/2 NPT	15M58B8	1.18 (30.1)	2.69 (68.3)
F312C150	3/4 NPT	10M512B8	1.38 (35.1)	2.88 (73.0)
F312C150	1 NPT			
F375C	W125	15M62B1	0.81 (20.6)	1.44 (36.5)
F375C	SW250	6M64B2	0.81 (20.6)	1.69 (42.8)
F375C	SW375	6M66B2	0.81 (20.6)	1.69 (42.8)
F375C	SW500	4M68B2	1.00 (25.4)	1.75 (44.5)
F375C	SF250CX	20M64B6	0.81 (20.6)	1.75 (44.5)
F375C	SF375CX	20M66B6	0.81 (20.6)	1.88 (47.6)
F375C	SF562CX	20M69B6	1.00 (25.4)	2.00 (50.8)
F375C	SF750CX	20M612B6	1.38 (35.1)	2.25 (57.2)
F375C	SF1000CX	20M616B6	1.75 (44.5)	3.25 (82.6)
F375C	F1000C43	43M616B6	1.75 (44.5)	3.25 (82.6)
F375C	F250C	60M64B3	0.81 (20.6)	1.63 (41.3)
F375C	F312C150	60M65B3	1.00 (25.4)	2.25 (57.2)
F375C	F375C	60M66B3	1.00 (25.4)	1.88 (47.63)
F375C	F562C	60M69B3	1.38 (35.1)	1.63 (41.3)
F375C	F562C40			
F375C	1/8 NPT	15M62B8	0.81 (20.6)	1.50 (38.1)
F375C	1/4 NPT	15M64B8	0.81 (20.6)	1.75 (44.5)
F375C	3/8 NPT	15M66B8	1.00 (25.4)	2.00 (50.8)
F375C	1/2 NPT	15M68B8	1.18 (30.1)	2.25 (57.2)
F375C	3/4 NPT	10M612B8	1.38 (35.1)	2.50 (63.5)
F375C	1 NPT	10M616B8	1.75 (44.5)	2.75 (69.9)

Male End Fits this Connection	Female End	Catalog Number	Dimension inches (mm)	
			A Hex	B
F562C	W125	15M92B1	1.18 (30.1)	1.50 (38.1)
F562C	SW250	6M94B2	1.18 (30.1)	1.69 (42.8)
F562C	SW375	6M96B2	1.18 (30.1)	1.69 (42.8)
F562C	SW500	4M98B2	1.18 (30.1)	1.75 (44.5)
F562C	SF250CX	20M94B6	1.18 (30.1)	1.69 (42.8)
F562C	SF375CX	20M96B6	1.18 (30.1)	1.81 (46.0)
F562C	SF562CX	20M99B6	1.18 (30.1)	1.94 (49.2)
F562C	SF750CX	20M912B6	1.38 (35.1)	2.31 (58.7)
F562C	SF1000CX	20M916B6	1.75 (44.5)	3.31 (84.1)
F562C	F1000C43	43M916B3	1.75 (44.5)	3.31 (84.1)
F562C	F250C	60M94B3	1.18 (30.1)	1.69 (42.8)
F562C	F312C150	60M95B3	1.18 (30.1)	2.31 (58.7)
F562C	F375C	60M96B3	1.18 (30.1)	1.88 (47.6)
F562C	F562C	60M99B3	1.38 (35.1)	2.31 (58.7)
F562C	F562C40			
F562C	1/8 NPT	15M92B8	0.94 (23.8)	1.81 (46.0)
F562C	1/4 NPT	15M94B8	0.94 (23.8)	1.81 (46.0)
F562C	3/8 NPT	15M96B8	0.94 (23.8)	1.81 (46.0)
F562C	1/2 NPT	15M98B8	1.18 (30.1)	2.13 (54.0)
F562C	3/4 NPT	10M912B8	1.50 (38.1)	2.31 (58.7)
F562C	1 NPT	10M916B8	1.75 (44.5)	1.69 (42.8)
F562C40	W125			
F562C40	SW250			
F562C40	SW375			
F562C40	SW500			
F562C40	SF250CX			
F562C40	SF375CX			
F562C40	SF562CX			
F562C40	SF750CX	20M912G6	1.38 (35.1)	2.50 (63.5)
F562C40	SF1000CX			
F562C40	F1000C43			
F562C40	F250C			
F562C40	F312C150			
F562C40	F375C			
F562C40	F562C			
F562C40	F562C40			
F562C40	1/8 NPT			
F562C40	1/4 NPT			
F562C40	3/8 NPT			
F562C40	1/2 NPT	15M98G8	1.18 (30.1)	2.13 (54.0)
F562C40	3/4 NPT			
F562C40	1 NPT			

Maximum pressure rating is based on the lowest rating of any component. Actual working pressure may be determined by tubing pressure rating, if lower.

Note: For pressure rating see selection chart.

All Dimensions for reference only and subject to change.

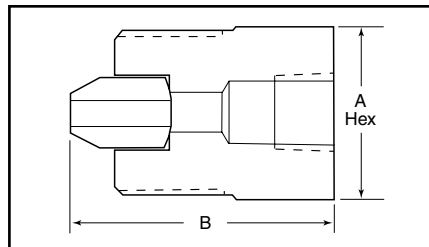

Adapter configurations may vary from outline shown

For prompt service, Parker Autoclave Engineers stocks select products. Consult factory.

Flat Bottom

Male End Fits this Connection	Female End	Catalog Number	Dimension inches (mm)	
			A Hex	B

F437FB	W125	15M72E1	0.50 (12.7)	1.41 (35.8)
F437FB	SW250	6M74E2	0.63 (15.9)	1.53 (38.9)
F437FB	SW375	6M76E2	0.75 (19.1)	1.91 (48.4)
F437FB	SW500	4M78E2	1.00 (25.4)	2.16 (54.8)
F437FB	SF250CX	15M74E6	0.63 (15.9)	1.53 (38.9)
F437FB	SF375CX	15M76E6	0.75 (19.1)	1.78 (45.2)
F437FB	SF562CX	15M79E6	1.00 (25.4)	1.91 (48.4)
F437FB	SF750CX			
F437FB	SF1000CX			
F437FB	F1000C43			
F437FB	F250C	15M74E3	0.75 (19.1)	1.53 (38.9)
F437FB	F312C150			
F437FB	F375C	15M76E3	1.00 (25.4)	1.78 (45.2)
F437FB	F562C	15M79E3	1.38 (35.1)	2.03 (51.6)
F437FB	F562C40			
F437FB	1/8 NPT	10M72E8	0.63 (15.9)	1.59 (40.4)
F437FB	1/4 NPT	10M74E8	0.75 (19.1)	1.78 (45.2)
F437FB	3/8 NPT	10M76E8	1.00 (25.4)	1.91 (48.4)
F437FB	1/2 NPT	10M78E8	1.18 (30.1)	2.16 (54.8)
F437FB	3/4 NPT			
F437FB	1 NPT			

F562FB	W125	15M92E1	0.63 (15.9)	1.44 (36.5)
F562FB	SW250	6M94E2	0.75 (19.1)	2.06 (52.4)
F562FB	SW375	6M96E2	0.75 (19.1)	2.25 (57.2)
F562FB	SW500	4M98E2	1.00 (25.4)	2.18 (55.5)
F562FB	SF250CX	15M94E6	0.63 (15.9)	1.81 (46.0)
F562FB	SF375CX	15M96E6	0.75 (19.1)	2.06 (52.4)
F562FB	SF562CX	15M99E6	1.00 (25.4)	1.18 (30.1)
F562FB	SF750CX	15M912E6	1.38 (35.1)	2.81 (71.4)
F562FB	SF1000CX			
F562FB	F1000C43			
F562FB	F250C	15M94E3	0.81 (20.6)	1.94 (49.2)
F562FB	F312C150			
F562FB	F375C	15M96E3	1.00 (25.4)	2.44 (61.9)
F562FB	F562C			
F562FB	F562C40			
F562FB	1/8 NPT	10M92E8	0.63 (15.9)	1.94 (49.2)
F562FB	1/4 NPT	10M94E8	0.75 (19.1)	2.18 (55.5)
F562FB	3/8 NPT	10M96E8	1.00 (25.4)	2.31 (58.7)
F562FB	1/2 NPT	10M98E8	1.18 (30.1)	1.63 (41.3)
F562FB	3/4 NPT	10M912E8	1.38 (35.1)	2.06 (52.4)
F562FB	1 NPT	10M916E8	1.88 (47.6)	2.25 (57.2)

Male End Fits this Connection	Female End	Catalog Number	Dimension inches (mm)	
			A Hex	B

F750FB	W125	15M122E1	0.75 (19.1)	1.69 (42.8)
F750FB	SW250	6M124E2	0.81 (20.6)	2.06 (52.4)
F750FB	SW375	6M126E2	0.75 (19.1)	1.94 (49.2)
F750FB	SW500	4M128E2	1.00 (25.4)	2.18 (55.5)
F750FB	SF250CX	15M124E6	0.81 (20.6)	1.94 (49.2)
F750FB	SF375CX	15M126E6	0.81 (20.6)	2.06 (52.4)
F750FB	SF562CX	15M129E6	1.00 (25.4)	1.31 (33.3)
F750FB	SF750CX	15M1212E6	1.38 (35.1)	1.69 (42.8)
F750FB	SF1000CX	15M1216E6	1.75 (44.5)	3.31 (84.1)
F750FB	F1000C43			
F750FB	F250C	15M124E3	1.00 (25.4)	1.94 (49.2)
F750FB	F312C150			
F750FB	F375C	15M126E3	1.00 (25.4)	2.18 (55.5)
F750FB	F562C	15M129E3	1.38 (35.1)	2.31 (58.7)
F750FB	F562C40			
F750FB	1/8 NPT	10M122E8	0.94 (23.8)	1.81 (46.0)
F750FB	1/4 NPT	10M124E8	1.00 (25.4)	2.31 (58.7)
F750FB	3/8 NPT	10M126E8	1.00 (25.4)	2.18 (55.5)
F750FB	1/2 NPT	10M128E8	1.18 (30.1)	2.69 (68.3)
F750FB	3/4 NPT	10M1212E8	1.38 (35.1)	2.69 (68.3)
F750FB	1 NPT	10M1216E8	1.88 (47.6)	3.18 (81.0)

Flat Top

F562FT	W125	15M92R1	0.75 (19.1)	0.94 (23.9)
F562FT	SW250	6M94R2	0.75 (19.1)	1.50 (38.1)
F562FT	SW375	6M96R2	0.75 (19.1)	1.50 (38.1)
F562FT	SW500	4M98R2	1.00 (25.4)	1.63 (41.3)
F562FT	SF250CX	15M94R6	0.75 (19.1)	1.25 (31.8)
F562FT	SF375CX	15M96R6	0.75 (19.1)	1.50 (38.1)
F562FT	SF562CX	15M99R6	1.00 (25.4)	1.63 (41.3)
F562FT	SF750CX			
F562FT	SF1000CX			
F562FT	F1000C43			
F562FT	F250C	15M94R3	0.75 (19.1)	1.25 (31.8)
F562FT	F312C150			
F562FT	F375C	15M96R3	1.00 (25.4)	1.50 (38.1)
F562FT	F562C	15M99R3	1.38 (35.1)	1.75 (44.5)
F562FT	F562C40			
F562FT	1/8 NPT	10M92R8	0.75 (19.1)	1.25 (31.8)
F562FT	1/4 NPT	10M94R8	0.75 (19.1)	1.44 (36.5)
F562FT	3/8 NPT	10M96R8	0.94 (23.8)	1.56 (39.7)
F562FT	1/2 NPT	10M98R8	1.18 (30.1)	2.00 (50.8)
F562FT	3/4 NPT			
F562FT	1 NPT			

Maximum pressure rating is based on the lowest rating of any component. Actual working pressure may be determined by tubing pressure rating, if lower.

Note: For pressure rating see selection chart.

All Dimensions for reference only and subject to change.

For prompt service, Parker Autoclave Engineers stocks select products. Consult factory.

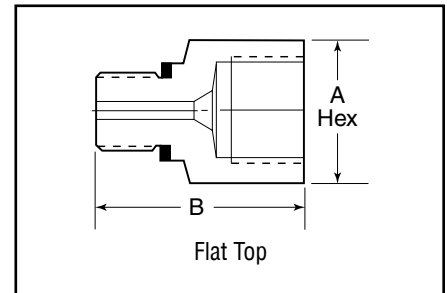
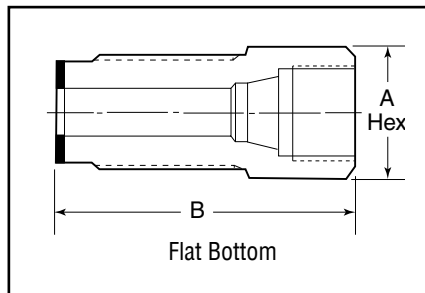

National Pipe Thread (NPT)

Male End Fits this Connection	Female End	Catalog Number	Dimension inches (mm)	
			A Hex	B
1/8 NPT	W125	15M22N1	0.50 (12.7)	1.00 (25.4)
1/8 NPT	SW250	15M24N2	0.63 (15.9)	1.25 (31.8)
1/8 NPT	SW375	15M26N2	0.75 (19.1)	1.44 (36.5)
1/8 NPT	SW500	10M28N2	1.00 (25.4)	1.50 (38.1)
1/8 NPT	SF250CX	15M24N6	0.63 (15.9)	1.81 (46.0)
1/8 NPT	SF375CX	15M26N6	0.75 (19.1)	1.38 (35.1)
1/8 NPT	SF562CX	15M29N6	1.00 (25.4)	1.75 (44.5)
1/8 NPT	SF750CX			
1/8 NPT	SF1000CX			
1/8 NPT	F1000C43			
1/8 NPT	F250C	15M24N3	0.75 (19.1)	1.25 (31.8)
1/8 NPT	F312C150			
1/8 NPT	F375C	15M26N3	1.00 (25.4)	1.50 (38.1)
1/8 NPT	F562C	15M29N3	1.38 (35.1)	1.63 (41.3)
1/8 NPT	F562C40			
1/8 NPT	1/8 NPT			
1/8 NPT	1/4 NPT	15M24N8	0.75 (19.1)	1.38 (35.1)
1/8 NPT	3/8 NPT			
1/8 NPT	1/2 NPT			
1/8 NPT	3/4 NPT			
1/8 NPT	1 NPT			
1/4 NPT	W125	15M42N1	0.63 (15.9)	1.13 (28.6)
1/4 NPT	SW250	15M44N2	0.63 (15.9)	1.38 (35.1)
1/4 NPT	SW375	15M46N2	0.75 (19.1)	1.50 (38.1)
1/4 NPT	SW500	10M48N2	1.00 (25.4)	1.75 (44.5)
1/4 NPT	SF250CX	15M44N6	0.63 (15.9)	1.38 (35.1)
1/4 NPT	SF375CX	15M46N6	0.75 (19.1)	1.56 (39.7)
1/4 NPT	SF562CX	15M49N6	1.00 (25.4)	1.75 (44.5)
1/4 NPT	SF750CX	15M412N6	1.38 (35.1)	2.25 (57.2)
1/4 NPT	SF1000CX	15M416N6	1.75 (44.5)	2.88 (73.0)
1/4 NPT	SF1500CX	15M424N6	2.25 (57.15)	3.48 (88.39)
1/4 NPT	F1000C43			
1/4 NPT	F250C	15M44N3	0.75 (19.1)	1.38 (35.1)
1/4 NPT	F312C150	15M45N3	1.00 (25.4)	2.50 (63.5)
1/4 NPT	F375C	15M46N3	1.00 (25.4)	1.63 (41.3)
1/4 NPT	F562C	15M49N3	1.38 (35.1)	1.75 (44.5)
1/4 NPT	F562C40			
1/4 NPT	1/8 NPT	15M42N8	0.63 (15.9)	1.38 (35.1)
1/4 NPT	1/4 NPT			
1/4 NPT	3/8 NPT	15M46N8	1.00 (25.4)	1.75 (44.5)
1/4 NPT	1/2 NPT	15M48N8	1.18 (30.1)	2.25 (57.2)
1/4 NPT	3/4 NPT			
1/4 NPT	1 NPT			

Male End Fits this Connection	Female End	Catalog Number	Dimension inches (mm)	
			A Hex	B
3/8 NPT	W125	15M62N1	0.75 (19.1)	1.13 (28.6)
3/8 NPT	SW250	15M64N2	0.75 (19.1)	1.38 (35.1)
3/8 NPT	SW375	15M66N2	0.75 (19.1)	1.50 (38.1)
3/8 NPT	SW500	10M68N2	1.00 (25.4)	1.75 (44.5)
3/8 NPT	SF250CX	15M64N6	0.75 (19.1)	1.38 (35.1)
3/8 NPT	SF375CX	15M66N6	0.75 (19.1)	1.50 (38.1)
3/8 NPT	SF562CX	15M69N6	1.00 (25.4)	1.75 (44.5)
3/8 NPT	SF750CX	15M612N6	1.38 (35.1)	2.00 (50.8)
3/8 NPT	SF1000CX	15M616N6	1.75 (44.5)	2.88 (73.0)
3/8 NPT	F1000C43			
3/8 NPT	F250C	15M64N3	0.75 (19.1)	1.38 (35.1)
3/8 NPT	F312C150			
3/8 NPT	F375C	15M66N3	1.00 (25.4)	1.63 (41.3)
3/8 NPT	F562C	15M69N3	1.38 (35.1)	1.75 (44.5)
3/8 NPT	F562C40	15M69N40	1.38 (35.1)	1.75 (44.5)
3/8 NPT	1/8 NPT			
3/8 NPT	1/4 NPT	15M64N8	0.75 (19.1)	1.63 (41.3)
3/8 NPT	3/8 NPT			
3/8 NPT	1/2 NPT	15M68N8	1.18 (30.1)	2.25 (57.2)
3/8 NPT	3/4 NPT			
3/8 NPT	1 NPT			
1/2 NPT	W125	15M82N1	1.00 (25.4)	2.50 (63.5)
1/2 NPT	SW250	15M84N2	1.00 (25.4)	1.63 (41.3)
1/2 NPT	SW375	15M86N2	1.00 (25.4)	1.63 (41.3)
1/2 NPT	SW500	10M88N2	1.00 (25.4)	1.88 (47.6)
1/2 NPT	SF250CX	15M84N6	1.00 (25.4)	1.38 (35.1)
1/2 NPT	SF375CX	15M86N6	1.00 (25.4)	1.63 (41.3)
1/2 NPT	SF562CX	15M89N6	1.00 (25.4)	1.94 (49.2)
1/2 NPT	SF750CX	15M812N6	1.38 (35.1)	2.18 (55.5)
1/2 NPT	SF1000CX	15M816N6	1.75 (44.5)	2.81 (71.4)
1/2 NPT	F1000C43			
1/2 NPT	F250C	15M84N3	1.00 (25.4)	1.50 (38.1)
1/2 NPT	F312C150			
1/2 NPT	F375C	15M86N3	1.00 (25.4)	1.75 (44.5)
1/2 NPT	F562C	15M89N3	1.38 (35.1)	1.88 (47.6)
1/2 NPT	F562C40	15M89N40	1.38 (35.1)	1.75 (44.5)
1/2 NPT	1/8 NPT			
1/2 NPT	1/4 NPT	15M84N8	1.00 (25.4)	1.75 (44.5)
1/2 NPT	3/8 NPT	15M86N8	1.00 (25.4)	1.81 (47.4)
1/2 NPT	1/2 NPT			
1/2 NPT	3/4 NPT	10M812N8	1.38 (35.1)	2.25 (57.2)
1/2 NPT	1 NPT			

*Maximum pressure rating is based on the lowest rating of any component. Actual working pressure may be determined by tubing pressure rating, if lower.

Note: For pressure rating see selection chart.

All Dimensions for reference only and subject to change.

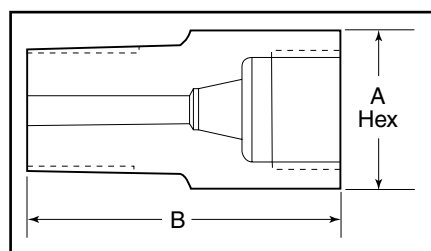

For prompt service, Parker Autoclave Engineers stocks select products. Consult factory.

National Pipe Thread (NPT)

Male End Fits this Connection	Female End	Catalog Number	Dimension inches (mm)	
			A Hex	B
3/4 NPT	W125			
3/4 NPT	SW250	10M124N2	1.18 (30.1)	1.75 (44.5)
3/4 NPT	SW375	10M126N2	1.18 (30.1)	1.75 (44.5)
3/4 NPT	SW500	10M128N2	1.18 (30.1)	1.75 (44.5)
3/4 NPT	SF250CX	10M124N6	1.18 (30.1)	1.75 (44.5)
3/4 NPT	SF375CX	10M126N6	1.18 (30.1)	1.75 (44.5)
3/4 NPT	SF562CX	10M129N6	1.38 (35.1)	2.00 (50.8)
3/4 NPT	SF750CX	10M1212N6	1.38 (35.1)	2.25 (57.2)
3/4 NPT	SF1000CX	10M1216N6	1.75 (44.5)	2.88 (73.0)
3/4 NPT	F1000C43			
3/4 NPT	F250C	10M124N3	1.18 (30.1)	1.75 (44.5)
3/4 NPT	F312C150			
3/4 NPT	F375C	10M126N3	1.18 (30.1)	2.00 (50.8)
3/4 NPT	F562C	10M129N3	1.38 (35.1)	2.13 (54.0)
3/4 NPT	F562C40			
3/4 NPT	1/8 NPT	10M122N8	1.18 (30.1)	1.63 (41.3)
3/4 NPT	1/4 NPT	10M124N8	1.18 (30.1)	1.63 (41.3)
3/4 NPT	3/8 NPT			
3/4 NPT	1/2 NPT			
3/4 NPT	3/4 NPT			
3/4 NPT	1 NPT			

Male End Fits this Connection	Female End	Catalog Number	Dimension inches (mm)	
			A Hex	B
1 NPT	W125			
1 NPT	SW250			
1 NPT	SW375	10M166N2	1.38 (35.1)	1.75 (44.5)
1 NPT	SW500	10M168N2	1.38 (35.1)	1.75 (44.5)
1 NPT	SF250CX			
1 NPT	SF375CX	10M166N6	1.38 (35.1)	2.00 (50.8)
1 NPT	SF562CX	10M169N6	1.38 (35.1)	2.25 (57.2)
1 NPT	SF750CX	10M1612N6	1.38 (35.1)	2.63 (66.7)
1 NPT	SF1000CX	10M1616N6	1.75 (44.5)	3.06 (77.8)
1 NPT	F1000C43			
1 NPT	F250C			
1 NPT	F312C150			
1 NPT	F375C	10M166N3	1.38 (35.1)	2.00 (50.8)
1 NPT	F562C	10M169N3	1.38 (35.1)	2.25 (57.2)
1 NPT	F562C40			
1 NPT	1/8 NPT			
1 NPT	1/4 NPT			
1 NPT	3/8 NPT			
1 NPT	1/2 NPT	10M168N8	1.38 (35.1)	2.25 (57.2)
1 NPT	3/4 NPT			
1 NPT	1 NPT			

Maximum pressure rating is based on the lowest rating of any component. Actual working pressure may be determined by tubing pressure rating, if lower.

Note: For pressure rating see selection chart.

All Dimensions for reference only and subject to change.

For prompt service, Parker Autoclave Engineers stocks select products. Consult factory.

NOTE: NPT (Pipe) connections

- NPT threads must be sealed using a high quality PTFE tape and/or PTFE paste product. Refer to thread sealant manufacturer's instructions on how to apply thread sealant.
- Sealing performance may vary based on many factors such as pressure, temperature, media, thread quality, thread material, proper thread engagement and proper use of thread sealant.
- Customer should limit the number of times an NPT fitting is assembled and disassembled because thread deformation during assembly will result in deteriorating seal quality over time. When using only PTFE tape, consider using thread lubrication to prevent galling of mating parts.

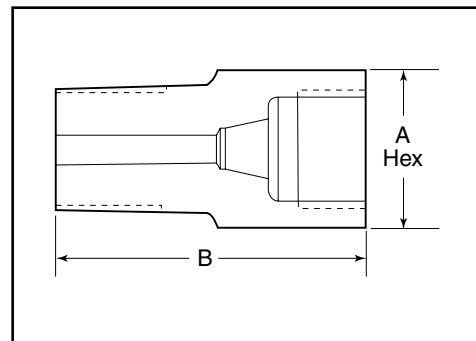

Adapters/Couplings - Couplings

The couplings shown here permit the joining of any combination of standard size tubing or tubing and standard pipe with female-to-female couplings. Other couplings available on special order.

Pressure Rating - The pressure rating of Parker Autoclave Engineers couplings is based on the lower rated connection used.

How to use the Ordering Chart below:

1. Locate "A" connection in the vertical column.
2. Locate the desired "B" connection across the top of the chart.
3. The catalog number of the required coupling is located at the intersection of the two columns.

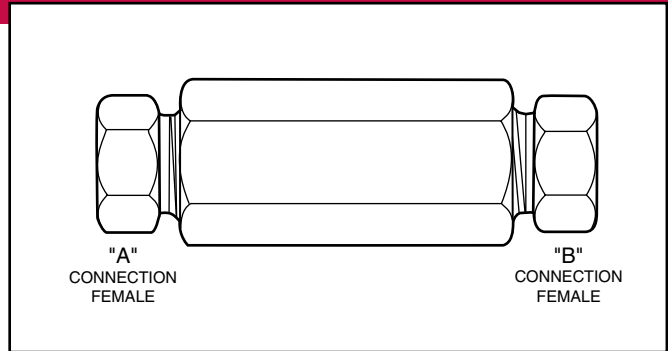

Note: Special material couplings may be supplied with four flats in place of standard hex.

"A" Connection				"B" Connection														
				SpeedBite				Medium Pressure				High Pressure						
Tube Outside in (mm)	Connector Type	Pressure psi (bar)*		1/8 W 125	1/4 SW 250	3/8 SW 375	1/2** SW 500	1/4 SF 250 CX	3/8 SF 375 CX	9/16 SF 562 CX	3/4 SF 750 CX	1 SF 1000 CX	1 F 1000 C43	1/4 F 250 C	3/8 F 375 C	9/16 F 562 C	9/16 F 562 C40	5/16 F 312 C150
SpeedBite	1/8 (3.18)	W125	15,000 (1034)	15F 2211	6F 2412	6F 2612	4F 2812	15F 2416	15F 2616	15F 2916		15F 21616		15F 2413	15F 2613	15F 2913		
	1/4 (6.35)	SW250	15,000 (1034)		6F 4422	6F 4622	4F 4822	6F 4426	6F 4626	6F 4926				6F 4423	6F 4623	6F 4923		
	3/8 (9.52)	SW375	15,000 (1034)			6F 6622	4F 6822	6F 6426	6F 6626	6F 6926	6F 61226	6F 61626		6F 6423	6F 6623	6F 6923		
	1/2 (12.70)	SW500	10,000 (690)				4F 8822	4F 8426	4F 8626	4F 8926	4F 81226	4F 81626		4F 8423	4F 8623	4F 8923		
Medium Pressure	1/4 (6.35)	SF250 CX	20,000 (1379)					20FX 4466	20F 4666	20F 4966	20F 41266	20F 41666	20F 41663	20F 4463	20F 4663	20F 4963		20F 4563
	3/8 (9.52)	SF375 CX	20,000 (1379)						20FX 6666	20F 6966	20F 61266	20F 61666	20F 61663	20F 6463	20F 6663	20F 6963		20F 6563
	9/16 (14.27)	SF562 CX	20,000 (1379)							20FX 9966	20F 91266	20F 91666		20F 9463	20F 9663	20F 9963		20F 9563
	3/4 (19.05)	SF750 CX	20,000 (1379)								20FX 12	20F 121666		20F 12463	20F 12663	20F 12963		20F 12563
	1 (25.40)	SF1000 CX	20,000 (1379)										20FX 16	20F 16463	20F 16663	20F 16963		20F 16563
High Pressure	1 (25.40)	F1000 C43	43,000 (2965)										43F 16					
	1/4 (6.35)	F250 C	60,000 (4137)										43F 41633	60F 4433	60F 4633	60F 4933		60F 4533
	3/8 (9.52)	F375 C	60,000 (4137)										43F 61633		60F 6633	60F 6933		60F 6533
	9/16 (14.27)	F562 C	60,000 (4137)										43F 91633			60F 9933		60F 9533
	9/16 (14.27)	F562 C40	40,000 (2760)														40F 9933	
	5/16 (7.92)	F312 C150	15,000 (1034)															
National Pipe Thread (NPT)	1/8 (3.18)	NPT	15,000 (1034)	15F 2281	15F 2482	15F 2682	10F 2882	15F 2486	15F 2686	15F 2986	15F 21286			15F 2483	15F 2683	15F 2983		15F 2583
	1/4 (6.35)	NPT	15,000 (1034)	15F 4281	15F 4482	15F 4682	10F 4882	15F 4486	15F 4686	15F 4986	15F 41286	15F 41686		15F 4483	15F 4683	15F 4983		15F 4583
	3/8 (9.52)	NPT	15,000 (1034)	15F 6281	15F 6482	15F 6682	10F 6882	15F 6486	15F 6686	15F 6986	15F 61286	15F 61686		15F 6483	15F 6683	15F 6983		15F 6583
	1/2 (12.70)	NPT	15,000 (1034)	15F 8281	15F 8482	15F 8682	10F 8882	15F 8486	15F 8686	15F 8986	15F 81286	15F 81686		15F 8483	15F 8683	15F 8983		15F 8583
	3/4 (19.05)	NPT	10,000 (1034)				10F 12882		10F 12686	10F 12986	10F 121286	10F 121686				10F 12983		
	1 (25.40)	NPT	10,000 (1034)							10F 16986		10F 161686		10F 16483		10F 16983		

*Maximum pressure rating is based on the lowest rating of any component. Actual working pressure may be determined by tubing pressure rating, if lower.
 **1/2 low pressure rated to 10,000 psi.

All dimensions for reference only and subject to change.
 For prompt service, Parker Autoclave Engineers stocks select products. Consult your local representative. CAUTION: See appropriate pressure section in reference to proper selection of tubing.

Coupling Dimensions - Speedbite

Connection "A"	Connection "B"	Catalog Number	Dimension inches (mm)	
			A Hex	B
W125	W125	15F2211	0.50 (12.7)	1.25 (31.7)
W125	SW250	6F2412	0.63 (15.9)	1.44 (36.6)
W125	SW375	6F2612	0.75 (19.1)	1.50 (38.1)
W125	SW500	4F2812	1.00 (25.4)	1.63 (41.4)
W125	SF250CX	15F2416	0.63 (15.9)	1.38 (35.1)
W125	SF375CX	15F2616	0.75 (19.1)	1.50 (38.1)
W125	SF562CX	15F2916	1.00 (25.4)	1.75 (44.5)
W125	SF1000CX	15F21616	1.75 (44.5)	2.75 (69.9)
W125	F250C	15F2413	0.75 (19.1)	1.25 (31.7)
W125	F375C	15F2613	1.00 (25.4)	1.50 (38.1)
W125	F562C	15F2913	1.38 (35.1)	1.75 (44.5)
SW250	SW250	6F4422	0.63 (15.9)	1.63 (41.4)
SW250	SW375	6F4622	0.75 (19.1)	1.69 (42.9)
SW250	SW500	4F4822	1.00 (25.4)	1.88 (47.8)
SW250	SF250CX	6F4426	0.63 (15.9)	1.63 (41.4)
SW250	SF375CX	6F4626	0.75 (19.1)	1.75 (44.5)
SW250	SF562CX	6F4926	1.00 (25.4)	2.00 (50.8)
SW250	F250C	6F4423	0.75 (19.1)	1.50 (38.1)
SW250	F375C	6F4623	1.00 (25.4)	1.69 (42.9)
SW250	F562C	6F4923	1.38 (35.1)	2.06 (52.3)

Connection "A"	Connection "B"	Catalog Number	Dimension inches (mm)	
			A Hex	B
SW375	SW375	6F6622	0.75 (19.1)	1.75 (44.5)
SW375	SW500	4F6822	1.00 (25.4)	1.88 (47.8)
SW375	SF250CX	6F6426	0.75 (19.1)	0.88 (22.2)
SW375	SF375CX	6F6626	0.75 (19.1)	1.75 (44.5)
SW375	SF562CX	6F6926	1.00 (25.4)	2.00 (50.8)
SW375	SF750CX	6F61226	1.38 (35.1)	2.25 (57.2)
SW375	SF1000CX	6F61626	1.75 (44.5)	3.00 (76.2)
SW375	F250C	6F6423	0.75 (19.1)	1.63 (41.4)
SW375	F375C	6F6623	1.00 (25.4)	1.81 (46.0)
SW375	F562C	6F6923	1.38 (35.1)	2.00 (50.8)
SW500	SW500	4F8822	1.00 (25.4)	2.00 (50.8)
SW500	SF250CX	4F8426	1.00 (25.4)	1.63 (41.4)
SW500	SF375CX	4F8626	1.00 (25.4)	1.88 (47.8)
SW500	SF562CX	4F8926	1.00 (25.4)	2.00 (50.8)
SW500	SF750CX	4F81226	1.38 (35.1)	2.25 (57.2)
SW500	SF1000CX	4F81626	1.75 (44.5)	3.00 (76.2)
SW500	F250C	4F8423	1.00 (25.4)	1.69 (42.9)
SW500	F375C	4F8623	1.00 (25.4)	1.88 (47.8)
SW500	F562C	4F8923	1.38 (35.1)	2.06 (52.3)

Coupling Dimensions - Medium Pressure

Connection "A"	Connection "B"	Catalog Number	Dimension inches (mm)	
			A Hex	B
SF250CX	SF250CX	20FX4466	0.63 (15.9)	1.63 (41.4)
SF250CX	SF375CX	20F4666	0.75 (19.1)	1.75 (44.5)
SF250CX	SF562CX	20F4966	1.00 (25.4)	2.00 (50.8)
SF250CX	SF750CX	20F41266	1.38 (35.1)	2.25 (57.2)
SF250CX	SF1000CX	20F41666	1.75 (44.5)	2.75 (69.9)
SF250CX	F250C	20F4463	0.75 (19.1)	1.38 (35.1)
SF250CX	F375C	20F4663	1.00 (25.4)	1.63 (41.4)
SF250CX	F562C	20F4963	1.38 (35.1)	1.88 (47.8)
SF250CX	F312C150	20F4563	1.00 (25.4)	2.13 (54.1)
SF250CX	F1000C43	43F41663	1.75 (44.5)	2.75 (69.9)
SF375CX	SF375CX	20FX6666	0.75 (19.1)	1.75 (44.5)
SF375CX	SF562CX	20F6966	1.00 (25.4)	2.00 (50.8)
SF375CX	SF750CX	20F61266	1.38 (35.1)	2.25 (57.2)
SF375CX	SF1000CX	20F61666	1.75 (44.5)	2.88 (73.0)
SF375CX	F250C	20F6463	0.75 (19.1)	1.63 (41.4)
SF375CX	F375C	20F6663	1.00 (25.4)	2.00 (50.8)
SF375CX	F562C	20F6963	1.38 (35.1)	2.00 (50.8)
SF375CX	F312C150C	20F6563	1.00 (25.4)	2.25 (57.2)
SF375CX	F1000C43	43F61663	1.75 (44.5)	2.88 (73.0)
SF562CX	SF562CX	20FX9966	1.00 (25.4)	2.13 (54.1)
SF562CX	SF750CX	20F91266	1.38 (35.1)	2.50 (63.5)
SF562CX	SF1000CX	20F91666	1.75 (44.5)	3.00 (76.2)
SF562CX	F250C	20F9463	1.00 (25.4)	2.00 (50.8)
SF562CX	F375C	20F9663	1.00 (25.4)	2.00 (50.8)
SF562CX	F562C	20F9963	1.38 (35.1)	2.25 (57.2)
SF562CX	F312C150C	20F9563	1.00 (25.4)	2.50 (63.5)

Connection "A"	Connection "B"	Catalog Number	Dimension inches (mm)	
			A Hex	B
SF750CX	SF750CX	20FX12	1.38 (35.1)	2.50 (63.5)
SF750CX	SF1000CX	20F121666	1.75 (44.5)	3.00 (76.2)
SF750CX	F250C	20F12463	1.38 (35.1)	2.50 (63.5)
SF750CX	F375C	20F12663	1.38 (35.1)	2.38 (60.33)
SF750CX	F562C	20F12963	1.38 (35.1)	2.75 (69.9)
SF750CX	F312C150	20F12563	1.38 (35.1)	2.75 (69.9)
SF1000CX	SF1000CX	20FX16	1.75 (44.5)	3.50 (88.9)
SF1000CX	F250C	20F16463	1.75 (44.5)	2.75 (69.9)
SF1000CX	F375C	20F16663	1.75 (44.5)	2.88 (73.0)
SF1000CX	F562C	20F16963	1.75 (44.5)	3.25 (82.6)
SF1000CX	F312C150	20F16563	1.75 (44.5)	3.25 (82.6)

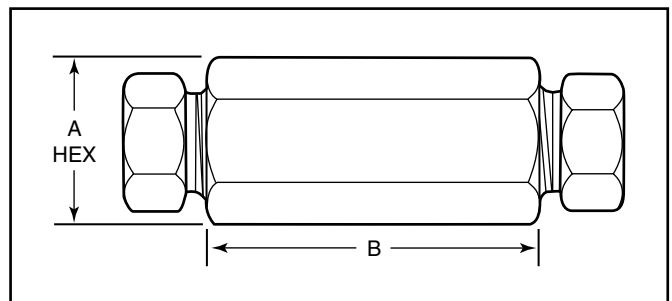

Maximum pressure rating is based on the lowest rating of any component.
Actual working pressure may be determined by tubing pressure rating, if lower.
Note: For pressure rating see selection chart.

All dimensions for reference only and subject to change.
For prompt service, Parker Autoclave Engineers stocks select products.
Consult your local representative.

Coupling Dimensions - High Pressure

Connection "A"	Connection "B"	Catalog Number	Dimension inches (mm)	
			A Hex	B
F250C	F250C	60F4433	0.75 (19.1)	1.38 (35.1)
F250C	F375C	60F4633	1.00 (25.4)	1.63 (41.4)
F250C	F562C	60F4933	1.38 (35.1)	1.75 (44.5)
F250C	F312C150	60F4533	1.00 (25.4)	2.00 (50.8)
F250C	F1000C43	43F41633	1.75 (44.5)	2.75 (69.9)
F375C	F375C	60F6633	1.00 (25.4)	1.75 (44.5)
F375C	F562C	60F6933	1.38 (35.1)	2.00 (50.8)
F375C	F312C150	60F6533	1.00 (25.4)	2.25 (57.2)
F375C	F1000C43	43F61633	1.75 (44.5)	2.88 (73.0)
F562C	F562C	60F9933	1.38 (35.1)	2.19 (55.6)
F562C40	F562C40	40F9933	1.38 (35.1)	2.19 (55.6)
F562C	F312C150	60F9533	1.19 (30.1)	2.63 (66.7)
F562C	SF1000C43	43F91633	1.75 (44.5)	3.75 (82.6)
F312C150	F312C150	150F5533	1.38 (35.1)	2.50 (63.5)
F1000C43	F1000C43	43F16	1.75 (44.5)	3.50 (88.9)

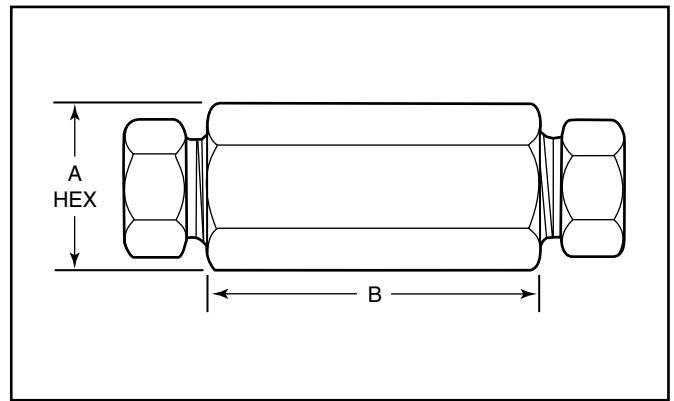

Coupling Dimensions - National Pipe Thread (NPT)

Connection "A"	Connection "B"	Catalog Number	Dimension inches (mm)	
			A Hex	B
1/8 NPT	W125	15F2281	0.63 (15.9)	1.38 (35.1)
1/8 NPT	SW250	15F2482	0.63 (15.9)	1.50 (38.1)
1/8 NPT	SW375	15F2682	0.75 (19.1)	1.63 (41.4)
1/8 NPT	SW500	10F2882	1.00 (25.4)	1.50 (38.1)
1/8 NPT	SF250CX	15F2486	0.63 (15.9)	1.38 (35.1)
1/8 NPT	SF375CX	15F2686	0.75 (19.1)	1.50 (38.1)
1/8 NPT	SF562CX	15F2986	1.00 (25.4)	1.63 (41.4)
1/8 NPT	SF750CX	15F21286	1.38 (35.1)	1.75 (44.5)
1/8 NPT	F250C	15F2483	0.75 (19.1)	1.38 (35.1)
1/8 NPT	F375C	15F2683	1.00 (25.4)	1.63 (41.4)
1/8 NPT	F562C	15F2983	1.38 (35.1)	1.82 (46.2)
1/8 NPT	F312C150	15F2583	1.00 (25.4)	2.13 (54.1)

Connection "A"	Connection "B"	Catalog Number	Dimension inches (mm)	
			A Hex	B
1/4 NPT	W125	15F4281	0.75 (19.1)	1.50 (38.1)
1/4 NPT	SW250	15F4482	0.75 (19.1)	1.63 (41.4)
1/4 NPT	SW375	15F4682	0.75 (19.1)	1.75 (44.5)
1/4 NPT	SW500	10F4882	1.00 (25.4)	2.00 (50.8)
1/4 NPT	SF250CX	15F4486	0.75 (19.1)	1.63 (41.4)
1/4 NPT	SF375CX	15F4686	0.75 (19.1)	1.75 (44.5)
1/4 NPT	SF562CX	15F4986	1.00 (25.4)	2.00 (50.8)
1/4 NPT	SF750CX	15F41286	1.38 (35.1)	1.75 (44.5)
1/4 NPT	SF1000CX	15F41686	1.38 (35.1)	2.38 (60.33)
1/4 NPT	F250C	15F4483	0.75 (19.1)	1.63 (41.4)
1/4 NPT	F375C	15F4683	1.00 (25.4)	1.88 (47.8)
1/4 NPT	F562C	15F4983	1.38 (35.1)	2.00 (50.8)
1/4 NPT	F312C150	15F4583	1.00 (25.4)	2.50 (63.5)

Maximum pressure rating is based on the lowest rating of any component.
Actual working pressure may be determined by tubing pressure rating, if lower.
Note: For pressure rating see selection chart.

All dimensions for reference only and subject to change.
For prompt service, Parker Autoclave Engineers stocks select products. Consult your local representative.

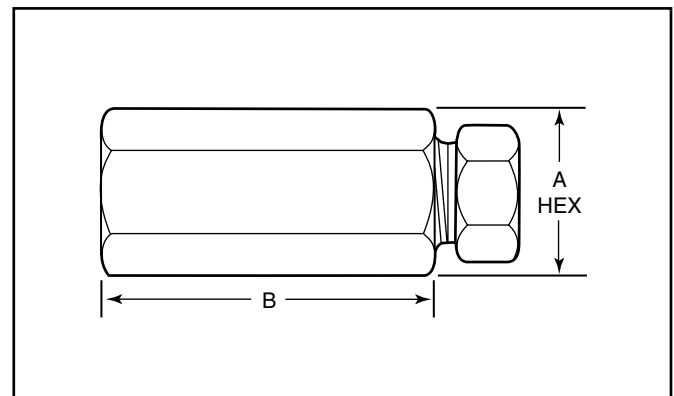

Coupling Dimensions - National Pipe Thread (NPT) - con't

Connection "A"	Connection "B"	Catalog Number	Dimension inches (mm)	
			A Hex	B
3/8 NPT	W125	15F6281	1.00 (25.4)	1.63 (41.1)
3/8 NPT	SW250	15F6482	1.00 (25.4)	1.75 (44.5)
3/8 NPT	SW375	15F6682	1.00 (25.4)	1.88 (47.8)
3/8 NPT	SW500	10F6882	1.00 (25.4)	2.00 (50.8)
3/8 NPT	SF250CX	15F6486	0.94 (23.9)	1.63 (41.4)
3/8 NPT	SF375CX	15F6686	0.94 (23.9)	1.82 (46.2)
3/8 NPT	SF562CX	15F6986	1.00 (25.4)	2.00 (50.8)
3/8 NPT	SF750CX	15F61286	1.38 (35.1)	2.38 (60.33)
3/8 NPT	SF1000CX	15F61686	1.75 (44.5)	2.50 (63.5)
3/8 NPT	F250C	15F6483	1.00 (25.4)	1.63 (41.4)
3/8 NPT	F375C	15F6683	1.00 (25.4)	1.88 (47.8)
3/8 NPT	F562C	15F6983	1.38 (35.1)	2.00 (50.8)
3/8 NPT	F312C150	15F6583	1.00 (25.4)	2.25 (57.2)
1/2 NPT	W125	15F8281	1.88 (47.8)	2.00 (50.8)
1/2 NPT	SW250	15F8482	1.88 (47.8)	2.13 (54.1)
1/2 NPT	SW375	15F8682	1.88 (47.8)	2.13 (54.1)
1/2 NPT	SW500	10F8882	1.19 (30.1)	2.25 (57.2)
1/2 NPT	SF250CX	15F8486	1.19 (30.1)	2.00 (50.8)
1/2 NPT	SF375CX	15F8686	1.19 (30.1)	2.13 (54.1)
1/2 NPT	SF562CX	15F8986	1.19 (30.1)	2.25 (57.2)
1/2 NPT	SF750CX	15F81286	1.38 (35.1)	2.63 (66.7)
1/2 NPT	SF1000CX	15F81686	1.75 (44.5)	3.00 (76.2)
1/2 NPT	F250C	15F8483	1.19 (30.1)	2.00 (50.8)
1/2 NPT	F375C	15F8683	1.19 (30.1)	2.13 (54.1)
1/2 NPT	F562C	15F8983	1.38 (35.1)	2.50 (63.5)
1/2 NPT	F312C150	15F8583	1.19 (30.1)	2.50 (63.5)

Connection "A"	Connection "B"	Catalog Number	Dimension inches (mm)	
			A Hex	B
3/4 NPT	SW500	10F12882	1.38 (35.1)	2.50 (63.5)
3/4 NPT	SF375CX	10F12686	1.38 (35.1)	2.25 (57.2)
3/4 NPT	SF562CX	10F12986	1.38 (35.1)	2.25 (57.2)
3/4 NPT	SF750CX	10F121286	1.50 (38.1)	2.63 (66.7)
3/4 NPT	SF1000CX	10F121686	1.75 (44.5)	3.00 (76.2)
3/4 NPT	F562C	10F12983	1.38 (35.1)	2.38 (60.33)
1 NPT	SF562CX	10F16986	1.75 (44.5)	2.63 (66.7)
1 NPT	SF1000CX	10F161686	1.75 (44.5)	2.88 (73.0)
1 NPT	F250C	10F16483	1.88 (47.8)	2.38 (60.33)
1 NPT	F562C	10F16983	1.75 (44.5)	2.50 (63.5)

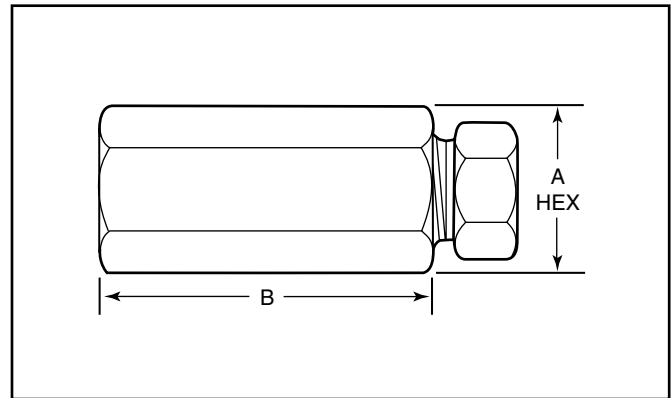

Maximum pressure rating is based on the lowest rating of any component.
 Actual working pressure may be determined by tubing pressure rating, if lower.
 Note: For pressure rating see selection chart.

All dimensions for reference only and subject to change.
 For prompt service, Parker Autoclave Engineers stocks select products. Consult your local representative.

NOTE: NPT (Pipe) connections

- NPT threads must be sealed using a high quality PTFE tape and/or PTFE paste product. Refer to thread sealant manufacturer's instructions on how to apply thread sealant.
- Sealing performance may vary based on many factors such as pressure, temperature, media, thread quality, thread material, proper thread engagement and proper use of thread sealant.
- Customer should limit the number of times an NPT fitting is assembled and disassembled because thread deformation during assembly will result in deteriorating seal quality over time. When using only PTFE tape, consider using thread lubrication to prevent galling of mating parts.

Adapters/Couplings - Male/Male Adapters

Parker Autoclave Engineer's standard male-to-male one piece adapters are available in low, medium, and high pressure configurations. Standard male-to-male adapters are machined from cold worked stainless steel. Other materials are available upon request. Contact your local Sales Representative for optional information. The following tables list our standard adapters with dimensions.



Adapter End Configuration

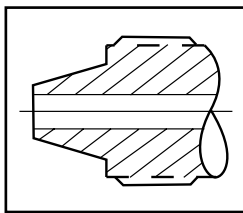

'L' Low Pressure

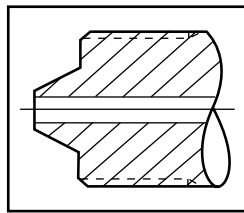

'H' High Pressure

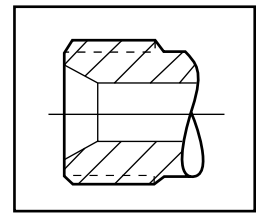

'RH' Reverse High Pressure

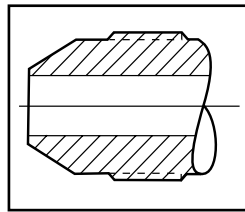

'M' Medium Pressure

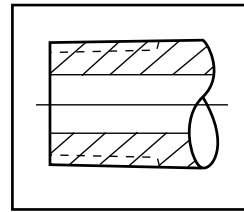

'P' National Pipe Tapered

Ordering Procedure

Typical catalog number: **20 MA M6 H9**

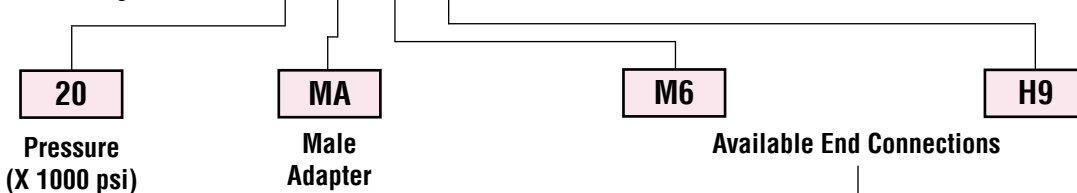

L2 - 1/8" Low Pressure	M4 - 1/4" Medium Pressure	H4 - 1/4" High Pressure	P4 - 1/4" NPT	*RH9 - 9/16" -18 Reverse High
L4 - 1/4" Low Pressure	M6 - 3/8" Medium Pressure	H5 - 5/16" High Pressure	P6 - 3/8" NPT	RH12 - 3/4" -16 Reverse High
L6 - 3/8" Low Pressure	M9 - 9/16" Medium Pressure	H6 - 3/8" High Pressure	P8 - 1/2" NPT	RH14 - 7/8" -14 Reverse High
L8 - 1/2" Low Pressure	M12 - 3/4" Medium Pressure	H9 - 9/16" High Pressure	P12 - 3/4" NPT	RH16 - 1" -12 Reverse High
	M16 - 1" Medium Pressure		P16 - 1" NPT	RH21 - 1-5/16" -12 Reverse High

Note: Special material one piece adapters may be supplied with four flats in place of standard hex.

*RH9 & RH14 - 40,000 psi (2758 bar), RH12 - 30,000 psi (2068 bar), RH16 - 26,000 psi (1793 bar), RH21 - 20,000 psi (1379 bar).

Low-Pressure to Low-Pressure Adapters

Catalog Number	Connection L/P	Connection L/P	Dimension inches (mm)	
			A Hex	B
15MAL2L2	W125	W125	0.50 (12.7)	1.38 (34.9)
15MAL2L4	W125	SW250	0.63 (15.9)	1.63 (41.3)
15MAL4L4	SW250	SW250	0.63 (15.9)	1.88 (47.6)
10MAL6L8	SW375	SW500	1.00 (25.4)	2.25 (57.1)
10MAL8L8	SW500	SW500	1.00 (25.4)	2.13 (54.0)

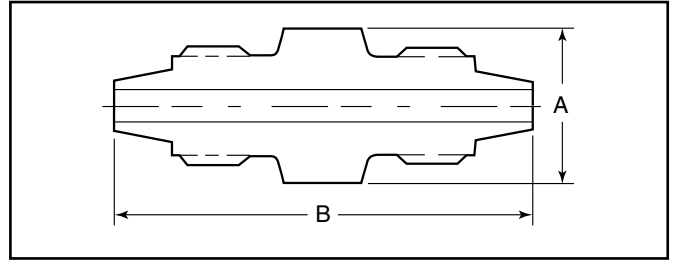

Low-Pressure to Medium-Pressure Adapters

Catalog Number	Connection L/P	Connection M/P	Dimension inches (mm)	
			A Hex	B
15MAL4M4	SW250	SF250CX	0.63 (15.9)	1.86 (47.3)
10MAL8M9	SW500	SF562CX	1.00 (25.4)	2.44 (62.0)

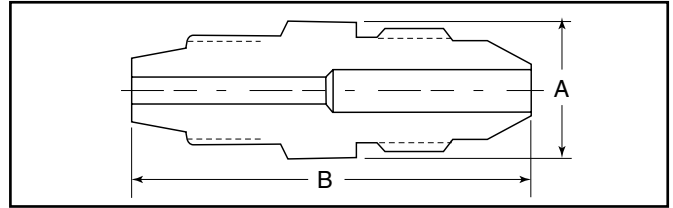

Low-Pressure to High-Pressure Adapters

Catalog Number	Connection L/P	Connection H/P	Dimension inches (mm)	
			A Hex	B
15MAL2H4	W125	F250C	0.63 (15.9)	1.63 (41.3)
15MAL2H6	W125	F375C	0.90 (25.4)	2.00 (50.8)

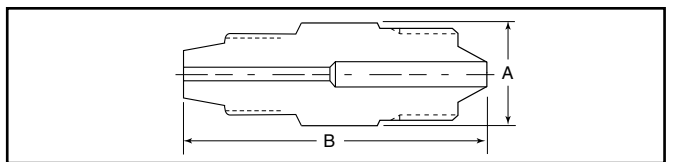

Medium-Pressure to Medium-Pressure Adapters

Catalog Number	Connection M/P	Connection M/P	Dimension inches (mm)	
			A Hex	B
20MAM4M4	SF250CX	SF250CX	0.50 (12.7)	1.69 (42.9)
20MAM4M6	SF250CX	SF375CX	0.63 (15.9)	1.88 (47.6)
20MAM4M9	SF250CX	SF562CX	0.94 (23.8)	2.38 (60.3)
20MAM4M12	SF250CX	SF750CX	1.19 (30.1)	2.69 (68.2)
20MAM4M16	SF250CX	SF1000CX	1.38 (34.9)	3.38 (85.7)
20MAM6M6	SF375CX	SF375CX	0.63 (15.9)	2.25 (57.1)
20MAM6M9	SF375CX	SF562CX	0.94 (23.8)	2.38 (60.3)
20MAM6M12	SF375CX	SF750CX	1.19 (30.1)	2.81 (71.4)
20MAM6M16	SF375CX	SF1000CX	1.38 (34.9)	3.38 (85.7)
20MAM9M9	SF562CX	SF562CX	0.94 (23.8)	2.50 (63.5)
20MAM9M12	SF562CX	SF750CX	1.19 (30.1)	3.00 (76.2)
20MAM9M16	SF562CX	SF1000CX	1.38 (34.9)	3.69 (93.72)
20MAM12M12	SF750CX	SF750CX	1.19 (30.1)	3.13 (79.3)
20MAM12M16	SF750CX	SF1000CX	1.38 (34.9)	3.81 (96.8)
20MAM16M4	SF1000CX	SF250CX	1.38 (34.9)	3.25 (82.6)
20MAM16M16	SF1000CX	SF1000CX	1.38 (34.9)	4.38 (111.1)

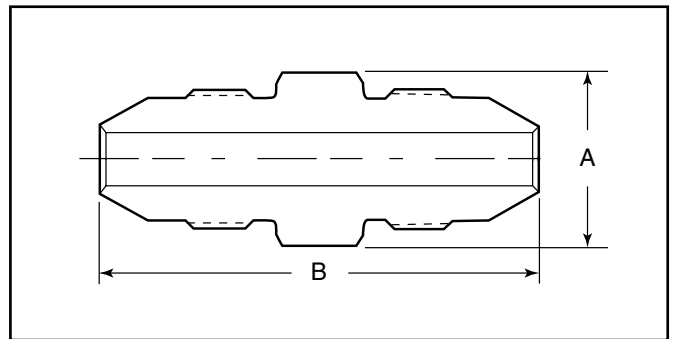

Medium-Pressure to High-Pressure Adapters

Catalog Number	Connection M/P	Connection H/P	Dimension inches (mm)	
			A Hex	B
20MAM4H4	SF250CX	F250C	0.63 (15.9)	1.75 (44.5)
20MAM4H6	SF250CX	F375C	0.81 (20.6)	2.13 (54.0)
20MAM4H9	SF250CX	F562C	1.19 (30.1)	2.63 (66.7)
20MAM6H4	SF375CX	F250C	0.63 (15.9)	1.94 (49.2)
20MAM6H6	SF375CX	F375C	0.81 (20.6)	2.38 (60.3)
20MAM6H9	SF375CX	F562C	1.19 (30.1)	2.69 (68.2)
20MAM9H4	SF562CX	F250C	0.81 (20.6)	2.25 (57.1)
20MAM9H6	SF562CX	F375C	0.81 (20.6)	2.56 (65.0)
20MAM9H9	SF562CX	F562C	1.19 (30.1)	2.94 (74.6)
20MAM12H4	SF750CX	F250C	1.19 (30.1)	2.63 (66.7)
20MAM12H6	SF750CX	F375C	1.19 (30.1)	2.88 (73.0)
20MAM12H9	SF750CX	F562C	1.19 (30.1)	3.00 (76.2)
20MAM16H4	SF1000CX	F250C	1.38 (34.9)	3.25 (82.6)
20MAM16H6	SF1000CX	F375C	1.38 (34.9)	3.50 (89.0)
20MAM16H9	SF1000CX	F562C	1.38 (34.9)	3.69 (93.6)

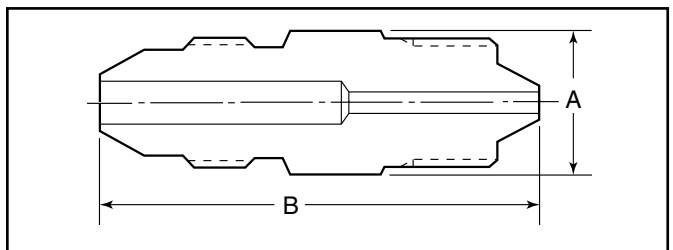

Maximum pressure rating is based on the lowest rating of any component. Actual working pressure may be determined by tubing pressure rating, if lower.

Note: For pressure rating see ordering procedure. All Dimensions for reference only and subject to change.

For prompt service, Parker Autoclave Engineers stocks select products. Consult factory.

High-Pressure to High-Pressure Adapters

Catalog Number	Connection H/P	Connection H/P	Dimension inches (mm)	
			A Hex	B
40MAH9H9	F562C40	F562C40	1.19 (30.1)	2.94 (74.6)
60MAH4H4	F250C	F250C	0.63 (15.9)	1.69 (42.8)
60MAH4H5	F250C	F312C150	0.75 (19.1)	2.63 (66.7)
60MAH4H6	F250C	F375C	0.81 (20.6)	2.13 (54.0)
60MAH4H9	F250C	F562C	1.19 (30.1)	2.56 (65.0)
60MAH5H6	F312C150	F375C	0.81 (20.6)	2.81 (71.4)
60MAH6H6	F375C	F375C	0.81 (20.6)	2.25 (57.1)
60MAH6H9	F375C	F562C	1.19 (30.1)	2.88 (73.0)
60MAH9H9	F562C	F562C	1.19 (30.1)	3.00 (76.2)
150MAH5H5	F312C150	F312C150	0.75 (19.1)	3.38 (85.7)

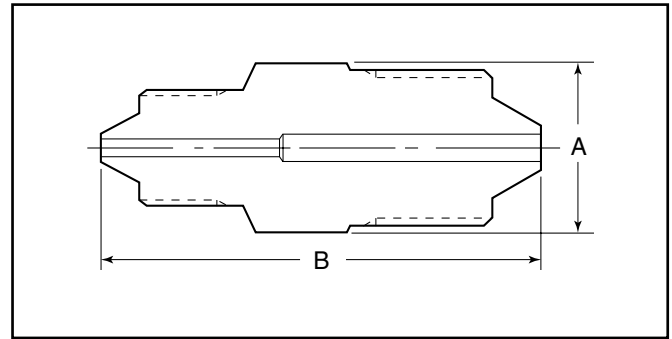

Low-Pressure to NPT Adapters

Catalog Number	Connection L/P	Connection NPT	Dimension inches (mm)	
			A Hex	B
15MAL2P2	W125	1/8"	0.50 (12.7)	1.38 (34.9)
15MAL2P4	W125	1/4"	0.63 (15.9)	1.63 (41.2)
15MAL2P8	W125	1/2"	1.00 (25.4)	2.13 (54.0)
15MAL4P8	SW250	1/2"	1.00 (25.4)	2.25 (57.1)
15MAL4P2	SW250	1/8"	0.63 (15.9)	1.63 (41.2)
15MAL4P4	SW250	1/4"	0.63 (15.9)	1.75 (44.5)
15MAL6P4	SW375	1/4"	0.75 (19.1)	1.88 (47.6)
15MAL6P8	SW375	1/2"	1.00 (25.4)	2.25 (57.1)
10MAL8P6	SW500	3/8"	1.00 (25.4)	2.00 (50.0)
10MAL8P8	SW500	1/2"	1.00 (25.4)	2.31 (58.7)
10MAL8P12	SW500	3/4"	1.19 (30.1)	2.38 (60.3)

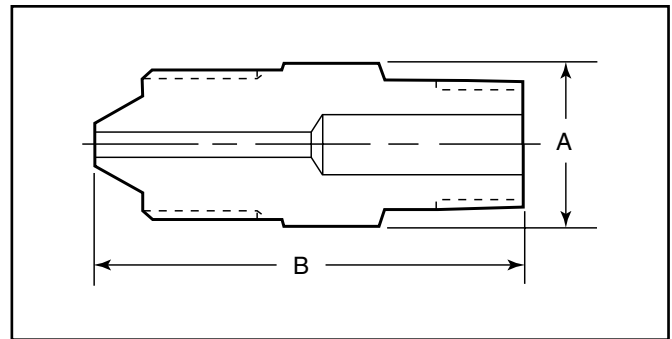

Medium-Pressure to NPT Adapters

Catalog Number	Connection M/P	Connection NPT	Dimension inches (mm)	
			A Hex	B
15MAM4P4	SF250CX	1/4"	0.63 (15.9)	1.75 (44.5)
15MAM4P6	SF250CX	3/8"	0.75 (19.1)	1.81 (46.2)
15MAM4P8	SF250CX	1/2"	0.94 (23.8)	2.19 (55.5)
15MAM6P4	SF375CX	1/4"	0.63 (15.9)	1.94 (49.1)
15MAM6P6	SF375CX	3/8"	0.75 (19.1)	2.00 (50.8)
15MAM6P8	SF375CX	1/2"	0.94 (23.8)	2.38 (60.3)
15MAM9P4	SF562CX	1/4"	0.81 (20.6)	2.25 (57.1)
15MAM9P6	SF562CX	3/8"	0.81 (20.6)	2.13 (54.0)
15MAM9P8	SF562CX	1/2"	0.94 (23.8)	2.56 (65.0)
10MAM9P12	SF562CX	3/4"	1.19 (30.1)	2.75 (69.9)
10MAM9P16	SF562CX	1"	1.38 (34.9)	3.00 (76.2)
15MAM12P4	SF750CX	1/4"	1.19 (30.1)	2.63 (66.7)
15MAM12P6	SF750CX	3/8"	1.19 (30.1)	2.63 (66.7)
15MAM12P8	SF750CX	1/2"	1.19 (30.1)	2.81 (71.4)
10MAM12P12	SF750CX	3/4"	1.19 (30.1)	2.81 (71.4)
10MAM12P16	SF750CX	1"	1.19 (30.1)	2.81 (71.4)
15MAM16P4	SF1000CX	1/4"	1.38 (34.9)	3.38 (85.7)
15MAM16P6	SF1000CX	3/8"	1.38 (34.9)	3.31 (84.1)
15MAM16P8	SF1000CX	1/2"	1.38 (34.9)	3.44 (87.3)
10MAM16P12	SF1000CX	3/4"	1.50 (38.1)	3.75 (95.3)
10MAM16P16	SF1000CX	1"	1.50 (38.1)	4.00 (101.6)

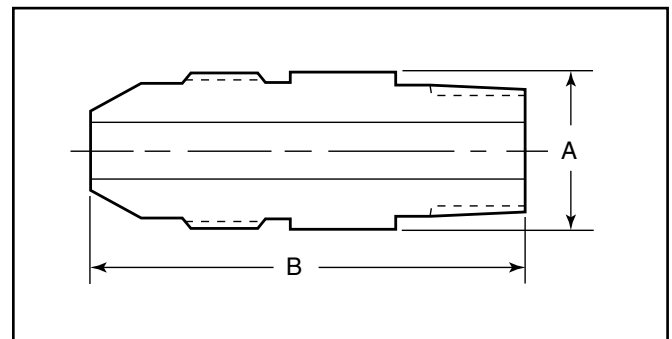

NOTE: NPT (Pipe) connections

- NPT threads must be sealed using a high quality PTFE tape and/or PTFE paste product. Refer to thread sealant manufacturer's instructions on how to apply thread sealant.
- Sealing performance may vary based on many factors such as pressure, temperature, media, thread quality, thread material, proper thread engagement and proper use of thread sealant.
- Customer should limit the number of times an NPT fitting is assembled and disassembled because thread deformation during assembly will result in deteriorating seal quality over time. When using only PTFE tape, consider using thread lubrication to prevent galling of mating parts.

Maximum pressure rating is based on the lowest rating of any component. Actual working pressure may be determined by tubing pressure rating, if lower.

Note: For pressure rating see ordering procedure.

All Dimensions for reference only and subject to change.

For prompt service, Parker Autoclave Engineers stocks select products. Consult factory.

High-Pressure to NPT Adapters

Catalog Number	Connection H/P	Connection NPT	Dimension inches (mm)	
			A Hex	B
15MAH4P4	F250C	1/4"	0.63 (15.9)	1.81 (46.2)
15MAH4P6	F250C	3/8"	0.75 (19.1)	1.88 (47.6)
15MAH4P8	F250C	1/2"	0.94 (23.8)	2.25 (57.1)
15MAH6P4	F375C	1/4"	0.81 (20.6)	2.13 (54.0)
15MAH6P6	F375C	3/8"	0.81 (20.6)	2.13 (54.0)
15MAH6P8	F375C	1/2"	0.94 (23.8)	2.50 (63.5)
15MAH9P4	F562C	1/4"	1.19 (30.1)	2.63 (66.7)
15MAH9P6	F562C	3/8"	1.19 (30.1)	2.56 (65.0)
15MAH9P8	F562C	1/2"	1.19 (30.1)	2.75 (69.9)

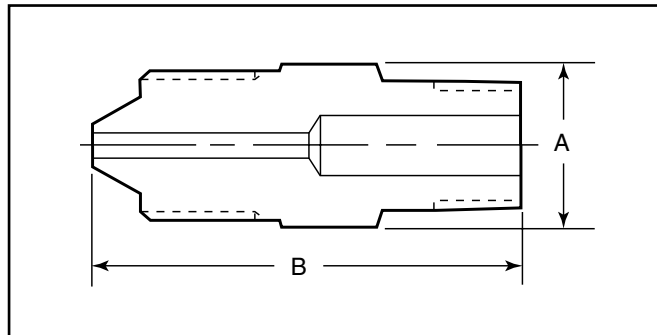

NPT to NPT Adapters

Catalog Number	Connection NPT	Connection NPT	Dimension inches (mm)	
			A Hex	B
15MAP4P4	1/4	1/4"	0.63 (15.9)	1.81 (46.2)
15MAP4P6	1/4	3/8"	0.75 (19.1)	1.88 (47.6)
15MAP4P8	1/4	1/2"	0.94 (23.8)	2.31 (58.7)
15MAP6P6	3/8	3/8"	0.75 (19.1)	1.88 (47.6)
15MAP6P8	3/8	1/2"	0.94 (23.8)	2.31 (58.7)
15MAP8P8	1/2	1/2"	0.94 (23.8)	2.50 (63.5)

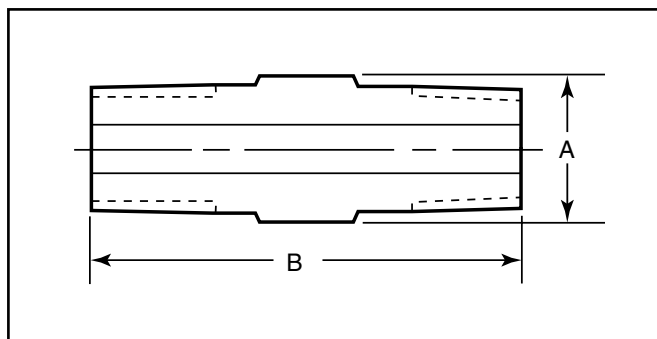

Medium-Pressure to Reverse High-Pressure Adapters

Catalog Number	Connection M/P	Connection RH	Dimension inches (mm)	
			A Hex	B
20MAM4RH9	SF250CX	9/16"	0.63 (15.9)	1.56 (39.7)
20MAM4RH12	SF250CX	3/4"	0.81 (20.6)	1.88 (47.6)
20MAM4RH16	SF250CX	1"	1.00 (25.4)	2.13 (54.0)
20MAM6RH9	SF375CX	9/16"	0.63 (15.9)	1.69 (42.8)
20MAM6RH12	SF375CX	3/4"	0.81 (20.6)	1.81 (46.2)
20MAM6RH16	SF375CX	1"	1.00 (25.4)	2.25 (57.1)
20MAM9RH9	SF562CX	9/16"	0.94 (23.8)	2.00 (50.8)
20MAM9RH12	SF562CX	3/4"	0.94 (23.8)	2.13 (54.0)
20MAM9RH14	SF562CX	7/8"	0.94 (23.8)	2.44 (61.9)
20MAM9RH16	SF562CX	1"	1.00 (25.4)	2.25 (57.1)
20MAM9RH21	SF562CX	1-5/16"	1.38 (34.9)	2.38 (60.3)
20MAM12RH9	SF750CX	9/16"	1.19 (30.1)	2.38 (60.3)
20MAM12RH12	SF750CX	3/4"	1.19 (30.1)	2.44 (61.9)
20MAM12RH16	SF750CX	1"	1.19 (30.1)	2.50 (63.5)
20MAM12RH21	SF750CX	1-5/16"	1.50 (38.1)	2.75 (69.9)
20MAM16RH9	SF1000CX	9/16"	1.38 (34.9)	3.13 (79.3)
20MAM16RH12	SF1000CX	3/4"	1.38 (34.9)	3.19 (80.9)
20MAM16RH14	SF1000CX	7/8"	1.38 (34.9)	3.34 (84.9)
20MAM16RH16	SF1000CX	1"	1.38 (34.9)	3.38 (85.7)
20MAM16RH21	SF1000CX	1-5/16"	1.50 (38.1)	3.25 (82.6)

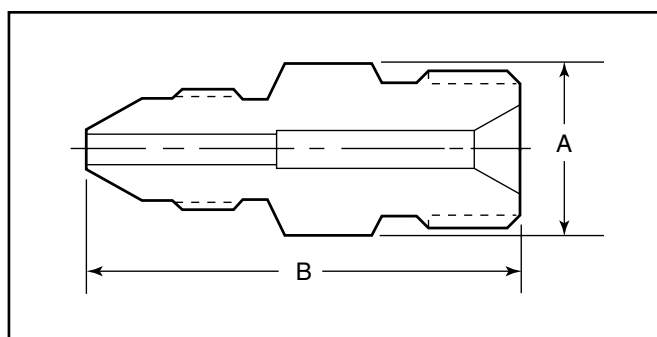

NOTE: NPT (Pipe) connections

- NPT threads must be sealed using a high quality PTFE tape and/or PTFE paste product. Refer to thread sealant manufacturer's instructions on how to apply thread sealant.
- Sealing performance may vary based on many factors such as pressure, temperature, media, thread quality, thread material, proper thread engagement and proper use of thread sealant.
- Customer should limit the number of times an NPT fitting is assembled and disassembled because thread deformation during assembly will result in deteriorating seal quality over time. When using only PTFE tape, consider using thread lubrication to prevent galling of mating parts.

Maximum pressure rating is based on the lowest rating of any component.
Actual working pressure may be determined by tubing pressure rating, if lower.
Note: For pressure rating see ordering procedure.

All Dimensions for reference only and are subject to change.

For prompt service, Parker Autoclave Engineers stocks select products. Consult factory.

High-Pressure to Reverse High-Pressure Adapters

Catalog Number	Connection H/P	Connection RH	Dimension inches (mm)	
			A Hex	B
26MAH4RH16	F250C	1"	1.00 (25.4)	2.13 (54.0)
26MAH6RH16	F375C	1"	1.00 (25.4)	2.25 (57.1)
26MAH9RH16	F562C	1"	1.19 (30.1)	2.69 (68.2)
30MAH4RH12	F250C	3/4"	0.81 (20.6)	1.88 (47.6)
30MAH6RH12	F375C	3/4"	0.81 (20.6)	2.06 (54.0)
30MAH9RH12	F562C	3/4"	1.19 (30.1)	2.50 (63.5)
40MAH4RH9	F250C	9/16"	0.63 (15.9)	1.56 (39.7)
40MAH6RH9	F375C	9/16"	0.81 (20.6)	1.94 (49.1)
40MAH9RH9	F562C	9/16"	1.19 (30.1)	2.38 (60.3)

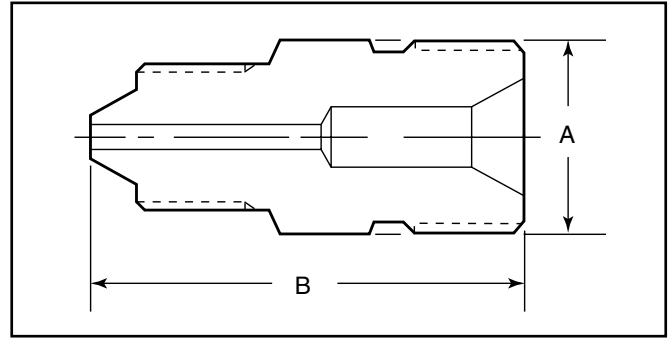

Reverse High-Pressure to Reverse High-Pressure Adapters

Catalog Number	Connection RH	Connection RH	Dimension inches (mm)	
			A Hex	B
20MARH21RH21	1-5/16	1-5/16"	1.38 (34.9)	2.13 (54.1)
26MARH9RH16	9/16	1"	1.00 (25.4)	1.88 (47.6)
26MARH12RH16	3/4	1"	1.00 (25.4)	2.00 (50.8)
26MARH16RH16	1	1"	1.00 (25.4)	2.00 (50.8)
30MARH9RH12	9/16	3/4"	0.81 (20.6)	1.63 (41.2)
30MARH12RH12	3/4	3/4"	0.81 (20.6)	1.75 (44.5)
40MARH9RH9	9/16	9/16"	0.63 (15.9)	1.50 (38.1)

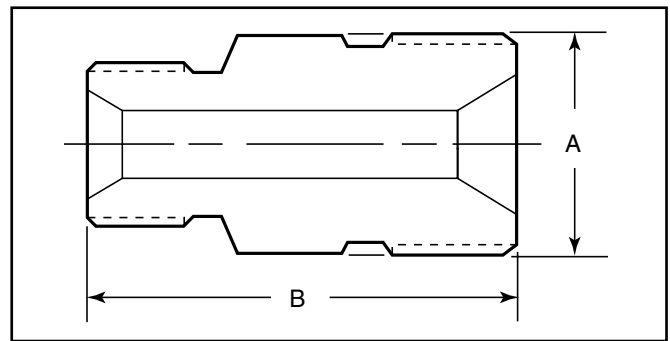

NPT to Reverse High-Pressure Adapters

Catalog Number	Connection NPT	Connection RH	Dimension inches (mm)	
			A Hex	B
15MAP4RH9	1/4	9/16"	0.63 (15.9)	1.63 (41.2)
15MAP4RH12	1/4	3/4"	0.81 (20.6)	1.88 (47.6)
15MAP4RH16	1/4	1"	1.00 (25.4)	2.25 (57.1)
15MAP6RH9	3/8	9/16"	0.75 (19.1)	1.81 (46.2)
15MAP6RH12	3/8	3/4"	0.81 (20.6)	1.94 (49.1)
15MAP6RH16	3/8	1"	1.00 (25.4)	2.13 (54.0)
15MAP8RH9	1/2	9/16"	0.94 (23.8)	2.00 (50.8)
15MAP8RH12	1/2	3/4"	0.94 (23.8)	2.13 (54.0)
15MAP8RH14	1/2	7/8"	1.00 (25.4)	2.25 (57.1)
15MAP8RH16	1/2	1"	1.00 (25.4)	2.31 (58.7)
10MAP12RH12	3/4	3/4"	1.19 (30.1)	2.31 (58.7)
10MAP12RH16	3/4	1"	1.38 (34.9)	2.63 (66.7)
10MAP12RH21	3/4	1-5/16"	1.38 (34.9)	2.63 (66.7)
10MAP16RH9	1	9/16"	1.38 (34.9)	2.25 (57.2)
10MAP16RH16	1	1"	1.38 (34.9)	2.81 (71.4)
10MAP16RH21	1	1-5/16"	1.38 (34.9)	2.68 (68.0)

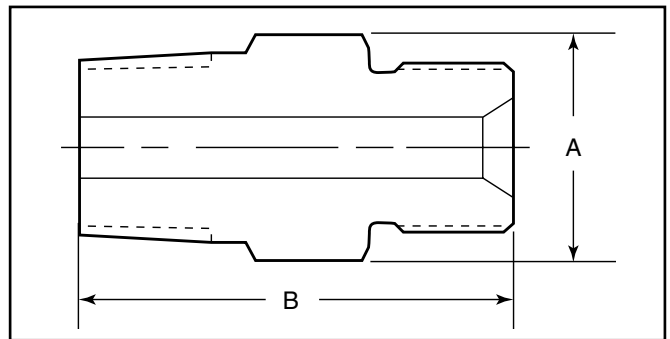

Maximum pressure rating is based on the lowest rating of any component.
Actual working pressure may be determined by tubing pressure rating, if lower.

Note: For pressure rating see ordering procedure.

All Dimensions for reference only and are subject to change.

For prompt service, Parker Autoclave Engineers stocks select products. Consult factory.

Male/Female Adapters - QSS Male/Female Adapters

Male /female adapters are designed to adapt a female connection to another size and/or type of connection without the need for additional couplings. In selecting an adapter involving two different sized connections, the larger connection should be on the male end where it is possible to maximize the mechanical strength of the adapter.

Materials

All Parker Autoclave Engineers adapters are precision machined from cold-worked Type 316 stainless steel.

To use this chart:

1. Locate MALE end in vertical column.
2. Locate desired FEMALE end of adapter across top of chart.
3. Catalog number of required adapter is located at intersection of columns.
4. For one piece adapter add-OP to suffix of part number.

		FEMALE END											
		Connection Size and Type		Quick Set				Medium Pressure					
		Fits this Female Connection	Pressure Rating PSI (bar)*	1/4" QS250	3/8" QS375	9/16" QS562	3/4" QS750	1/4" SF250CX	3/8" SF375CX	9/16" SF562CX	3/4" SF750CX	1" SF1000CX	
MALE END	Quick Set	1/4"	15,000 (1034.20)		15M46QQ	15M49QQ	15M412QQ	15M44Q6	15M46Q6	15M49Q6	15M412Q6	15M416Q6	
		3/8"	15,000 (1034.20)	15M64QQ		15M69QQ	15M612QQ	15M64Q6	15M66Q6	15M69Q6	15M612Q6	15M616Q6	
		9/16"	15,000 (1034.20)	15M94QQ	15M94QQ		15M912QQ	15M94Q6	15M96Q6	15M99Q6	15M912Q6	15M916Q6	
		3/4"	15,000 (1034.20)	15M124QQ	15M126QQ	15M129QQ		15M124Q6	15M126Q6	15M129Q6	15M1212Q6	15M1216Q6	
	Medium Pressure	1/4"	20,000 (1378.93)	15M44KQ	15M46KQ	15M49KQ	15M412KQ						
		3/8"	20,000 (1378.93)	15M64KQ	15M66KQ	15M69KQ	15M612KQ						
		9/16"	20,000 (1378.93)	15M94KQ	15M96KQ	15M99KQ	15M912KQ						
		3/4"	20,000 (1378.93)	15M124KQ	15M126KQ	15M129KQ	15M1212KQ						
		1"	20,000 (1378.93)	15M164KQ	15M166KQ	15M169KQ	15M1612KQ						
	High Pressure	1/4"	60,000 (4136.85)	15M44BQ	15M46BQ	15M49BQ	15M412BQ						
		3/8"	60,000 (4136.85)	15M64BQ	15M66BQ	15M69BQ	15M612BQ						
		9/16"	60,000 (4136.85)	15M94BQ	15M96BQ	15M99BQ	15M912BQ						
	National Pipe Thread (NPT)	1/4"	15,000 (1034.20)	15M44NQ	15M46NQ	15M49NQ	15M412NQ						
		3/8"	15,000 (1034.20)	15M64NQ	15M66NQ	15M69NQ	15M612NQ						
		1/2"	15,000 (689.45)	15M84NQ	15M86NQ	15M89NQ	15M812NQ						
		3/4"	10,000 (689.45)	10M124NQ	10M126NQ	10M129NQ	10M1212NQ						
		1"	10,000 (689.45)	10M164NQ	10M166NQ	10M169NQ	10M1612NQ						

Note:
 All Parker Autoclave Engineers adapters are supplied complete with appropriate gland nuts and sleeves unless specified without.
 * The maximum pressure rating for an adapter is determined by the connection component with the LOWEST pressure rating; that is, the two end connections and the tubing or pipe used, whichever is LOWER.
 CAUTION: See appropriate pressure section in reference to proper selection of tubing.

NOTE: NPT (Pipe) connections

- NPT threads must be sealed using a high quality PTFE tape and/or PTFE paste product. Refer to thread sealant manufacturer's instructions on how to apply thread sealant.
- Sealing performance may vary based on many factors such as pressure, temperature, media, thread quality, thread material, proper thread engagement and proper use of thread sealant.
- Customer should limit the number of times an NPT fitting is assembled and disassembled because thread deformation during assembly will result in deteriorating seal quality over time. When using only PTFE tape, consider using thread lubrication to prevent galling of mating parts.

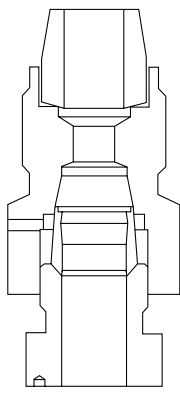

Quick Set Female
to
Quick Set Male

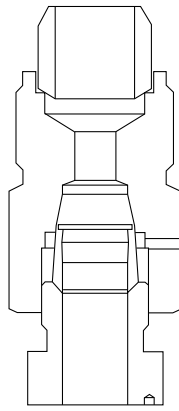

Quick Set Female
to
Medium Pressure Male

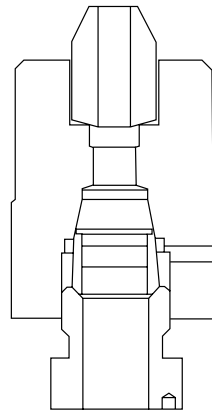

Quick Set Female
to
High Pressure Male

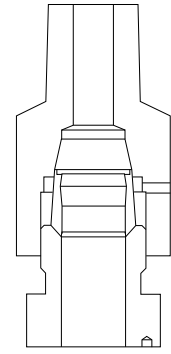

Quick Set Female
to
National Pipe Male

FEMALE END

High Pressure			National Pipe Thread (NPT)				
1/4" F250C	3/8" F375C	9/16" F562C	1/4" NPT	3/8" NPT	1/2" NPT	3/4" NPT	1" NPT
60,000 (4136.85)	60,000 (4136.85)	150,000 (10342.14)	15,000 (1034.20)	15,000 (1034.20)	15,000 (1034.20)	10,000 (689.45)	10,000 (689.45)
15M44Q3	15M46Q3	15M49Q3	15M44Q8	15M46Q8	15M48Q8	10M412Q8	10M416Q8
15M64Q3	15M66Q3	15M69Q3	15M64Q8	15M66Q8	15M68Q8	10M612Q8	10M616Q8
15M94Q3	15M96Q3	15M99Q3	15M94Q8	15M96Q8	15M98Q8	10M912Q8	10M916Q8
15M124Q3	15M126Q3	15M129Q3	15M124Q8	15M126Q8	15M128Q8	10M1212Q8	10M1216Q8

AE Male/Female Adapters are available in a "one-piece" design. They are identical to the two piece designs in length and can be ordered by adding the suffix - OP to the two piece adapter part numbers listed.

For prompt service, Parker Autoclave Engineers stocks select products. Consult factory.factory.

QS Series

Male End Fits this Connection	Female End	Catalog Number	Dimension inches (mm)	
			A Hex	B

QS250	QS250			
QS250	QS375	15M46QQ		
QS250	QS562	15M49QQ	1.38 (34.9)	2.25 (57.1)
QS250	QS750	15M412QQ		
QS250	SF250CX	15M44Q6		
QS250	SF375CX	15M46Q6		
QS250	SF562CX	15M49Q6		
QS250	SF750CX	15M412Q6		
QS250	SF1000CX	15M416Q6		
QS250	F250C	15M44Q3		
QS250	F375C	15M46Q3		
QS250	F562C	10M49Q3		
QS250	1/4 NPT	15M44Q8	0.75 (19.1)	1.69 (42.9)
QS250	3/8 NPT	15M46Q8		
QS250	1/2 NPT	15M48Q8		
QS250	3/4 NPT	10M412Q8		
QS250	1 NPT	10M416Q8		
QS375	QS250	15M64QQ	0.75 (19.1)	1.53 (38.9)
QS375	QS375			
QS375	QS562	15M69QQ		
QS375	QS750	15M612QQ	1.50 (38.1)	2.78 (70.6)
QS375	SF250CX	15M64Q6		
QS375	SF375CX	15M66Q6	0.75 (19.1)	1.66 (42.2)
QS375	SF562CX	15M69Q6	1.00 (25.4)	1.78 (45.2)
QS375	SF750CX	15M612Q6		
QS375	SF1000CX	15M616Q6		
QS375	F250C	15M64Q3		
QS375	F375C	15M66Q3		
QS375	F562C	15M69Q3		
QS375	1/4 NPT	15M64Q8	0.75 (19.1)	1.66 (42.2)
QS375	3/8 NPT	15M66Q8	1.00 (25.4)	1.78 (45.3)
QS375	1/2 NPT	15M68Q8	1.19 (30.1)	2.16 (54.8)
QS375	3/4 NPT	10M612Q8		
QS375	1 NPT	10M616Q8		

For prompt service, Parker Autoclave Engineers stocks select products. Consult factory.

Male End Fits this Connection	Female End	Catalog Number	Dimension inches (mm)	
			A Hex	B

QS562	QS250	15M94QQ	1.00 (25.4)	1.85 (46.8)
QS562	QS375	15M96QQ	1.00 (25.4)	1.85 (46.8)
QS562	QS562			
QS562	QS750	15M912QQ	1.50 (38.1)	3.16 (80.3)
QS562	SF250CX	15M94Q6		
QS562	SF375CX	15M96Q6		
QS562	SF562CX	15M99Q6		
QS562	SF750CX	15M912Q6		
QS562	SF1000CX	15M916Q6		
QS562	F250C	15M94Q3		
QS562	F375C	15M96Q3		
QS562	F562C	15M99Q3		
QS562	1/4 NPT	15M94Q8	1.19 (30.1)	2.22 (56.4)
QS562	3/8 NPT	15M96Q8	1.19 (30.1)	2.22 (56.4)
QS562	1/2 NPT	15M98Q8	1.19 (30.1)	2.41 (61.1)
QS562	3/4 NPT	10M912Q8		
QS562	1 NPT	10M916Q8		
QS750	QS250	15M124QQ		
QS750	QS375	15M126QQ	1.50 (38.1)	2.53 (64.1)
QS750	QS562	15M129QQ	1.50 (38.1)	2.53 (64.1)
QS750	QS750			
QS750	SF250CX	15M124Q6		
QS750	SF375CX	15M126Q6		
QS750	SF562CX	15M129Q6		
QS750	SF750CX	15M1212Q6		
QS750	SF1000CX	15M1216Q6		
QS750	F250C	15M124Q3		
QS750	F375C	15M126Q3		
QS750	F562C	15M129Q3		
QS750	1/4 NPT	15M124Q8		
QS750	3/8 NPT	15M126Q8		
QS750	1/2 NPT	15M128Q8	1.50 (38.1)	2.78 (70.5)
QS750	3/4 NPT	10M1212Q8		
QS750	1 NPT	10M1216Q8		

Maximum pressure rating is based on the lowest rating of any component. Actual working pressure may be determined by tubing pressure rating, if lower. Note: For pressure rating see selection chart.

All Dimensions for reference only and subject to change.

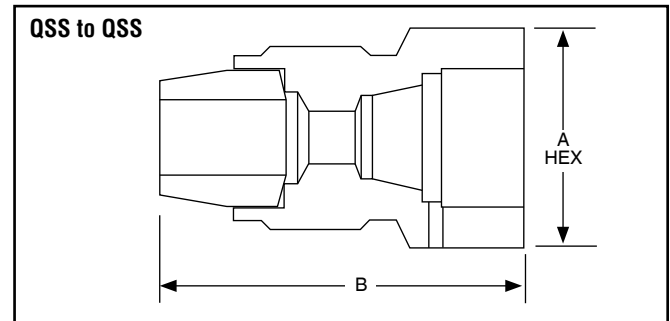
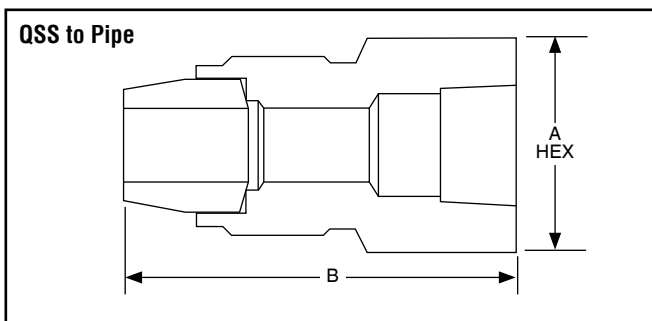

QS Series

Male End Fits this Connection	Female End	Catalog Number	Dimension inches (mm)	
			A Hex	B
SF250CX	QS250	15M44KQ	0.75 (19.1)	1.68 (42.7)
SF250CX	QS375	15M46KQ	0.81 (20.6)	1.68 (42.7)
SF250CX	QS562	15M49KQ	1.19 (30.1)	2.22 (56.4)
SF250CX	QS750	15M412KQ		
SF375CX	QS250	15M64KQ	0.75 (19.1)	1.63 (41.4)
SF375CX	QS375	15M66KQ	0.81 (20.6)	1.81 (46.1)
SF375CX	QS562	15M69KQ		
SF375CX	QS750	15M612KQ	1.50 (38.1)	3.00 (76.20)
SF562CX	QS250	15M94KQ	0.94 (23.8)	1.75 (44.5)
SF562CX	QS375	15M96KQ	0.94 (23.8)	1.75 (44.5)
SF562CX	QS562	15M99KQ	1.38 (34.9)	2.50 (63.5)
SF562CX	QS750	15M912KQ	1.50 (38.1)	3.25 (82.6)
SF750CX	QS250	15M124KQ		
SF750CX	QS375	15M126KQ		
SF750CX	QS562	15M129KQ		
SF750CX	QS750	15M1212KQ	1.50 (38.1)	3.06 (77.7)
SF1000CX	QS250	15M164KQ		
SF1000CX	QS375	15M166KQ		
SF1000CX	QS562	15M169KQ	1.50 (38.1)	2.88 (73.0)
SF1000CX	QS750	15M1612KQ	1.50 (38.1)	3.38 (85.7)

Male End Fits this Connection	Female End	Catalog Number	Dimension inches (mm)	
			A Hex	B
F250C	QS250	15M44BQ	0.75 (19.1)	1.31 (33.3)
F250C	QS375	15M46BQ	0.81 (20.6)	1.56 (39.7)
F250C	QS562	15M49BQ		
F250C	QS750	15M412BQ		
F375C	QS250	15M64BQ		
F375C	QS375	15M66BQ	0.81 (20.6)	1.69 (42.9)
F375C	QS562	15M69BQ		
F375C	QS750	15M612BQ		
F562C	QS250	15M94BQ	1.19 (30.1)	1.81(46.1)
F562C	QS375	15M96BQ	1.19 (30.1)	1.69 (42.9)
F562C	QS562	15M99BQ	1.38 (34.9)	2.32 (58.8)
F562C	QS750	15M912BQ	1.50 (38.1)	3.06 (77.7)

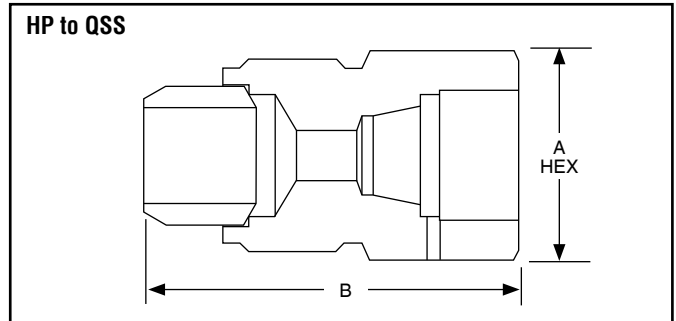
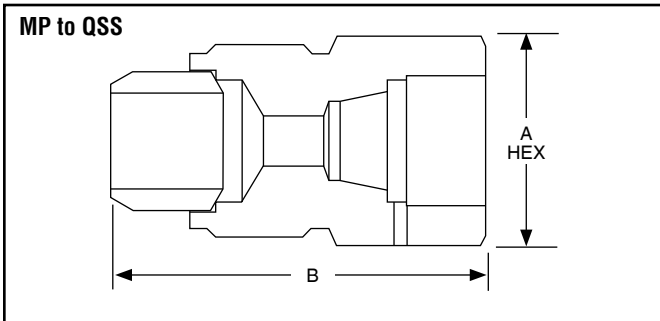

Maximum pressure rating is based on the lowest rating of any component.
 Actual working pressure may be determined by tubing pressure rating, if lower.
 Note: For pressure rating see selection chart.
 All Dimensions for reference only and subject to change.
 Adapter configurations may vary from outline shown.
 For prompt service, Parker Autoclave Engineers stocks select products. Consult factory.

Male End Fits this Connection	Female End	Catalog Number	Dimension inches (mm)	
			A Hex	B
1/4 NPT	QS250	15M44NQ	0.75 (19.1)	1.44 (36.5)
1/4 NPT	QS375	15M46NQ	0.81 (20.6)	1.63 (41.3)
1/4 NPT	QS562	15M49NQ		
1/4 NPT	QS750	15M412NQ		
3/8 NPT	QS250	15M64NQ	0.75 (19.1)	1.50 (38.1)
3/8 NPT	QS375	15M66NQ	0.81 (20.6)	1.63 (41.3)
3/8 NPT	QS562	15M69NQ	1.38 (35.1)	2.13 (53.5)
3/8 NPT	QS750	15M612NQ		
1/2 NPT	QS250	15M84NQ	0.94 (23.8)	1.75 (44.5)
1/2 NPT	QS375	15M86NQ	0.94 (23.8)	1.63 (41.3)
1/2 NPT	QS562	15M89NQ	1.38 (35.1)	2.25 (57.2)
1/2 NPT	QS750	15M812NQ	1.50 (38.1)	2.81 (71.4)
3/4 NPT	QS250	10M124NQ		
3/4 NPT	QS375	10M126NQ		
3/4 NPT	QS562	10M129NQ	1.38 (35.1)	2.38 (60.3)
3/4 NPT	QS750	10M1212NQ	1.50 (38.1)	2.81 (71.4)
1 NPT	QS250	10M164NQ		
1 NPT	QS275	10M166NQ		
1 NPT	QS562	10M169NQ	1.50 (38.1)	2.38 (60.3)
1 NPT	QS750	10M1612NQ	1.50 (38.1)	2.38 (60.3)

NPT to QSS

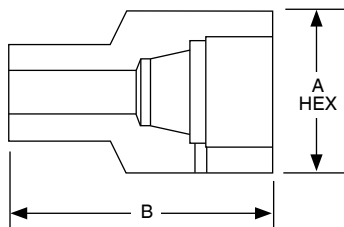

Maximum pressure rating is based on the lowest rating of any component.
 Actual working pressure may be determined by tubing pressure rating, if lower.
 Note: For pressure rating see selection chart.

All Dimensions for reference only and subject to change.

Adapter configurations may vary from outline shown.

For prompt service, Parker Autoclave Engineers stocks select products. Consult factory.

Male/Male Adapters - QSS Male/Male Adapters

Parker Autoclave Engineer's standard male-to-male one piece adapters are available in multiple configurations. Standard male-to-male adapters are machined from cold worked stainless steel. Contact your local Sales Representative for optional information. The following tables list our standard adapters with dimensions.

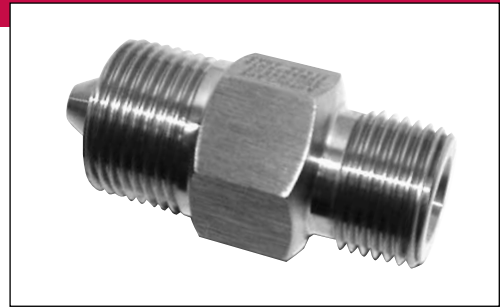

Adapter End Configuration

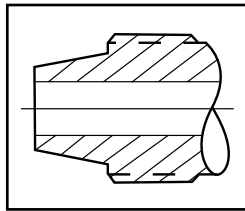

QS Series

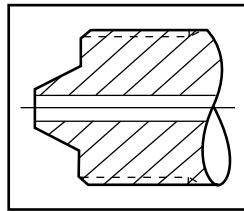

'H' High Pressure

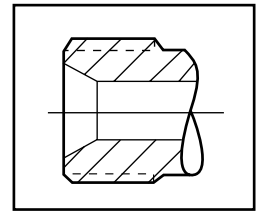

'RH' Reverse High Pressure

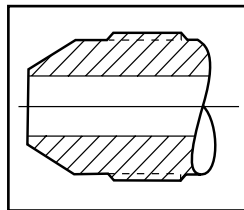

'M' Medium Pressure

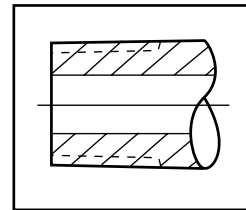

'P' National Pipe Tapered

Ordering Procedure

Typical catalog number: 15 MA Q4 H9

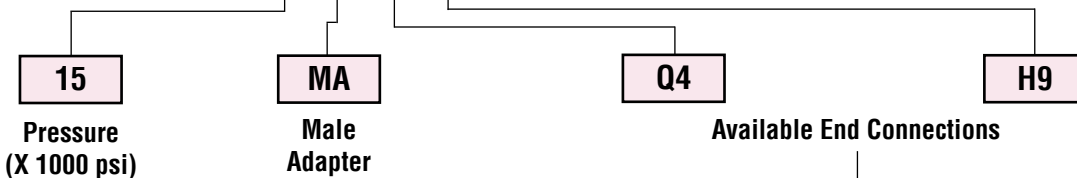

Q4 - 1/4" QS Series	M4 - 1/4" Medium Pressure	H4 - 1/4" High Pressure	P4 - 1/4" NPT	*RH9 - 9/16" -18 Reverse High
Q6 - 3/8" QS Series	M6 - 3/8" Medium Pressure	H5 - 5/16" High Pressure	P6 - 3/8" NPT	RH12 - 3/4" -16 Reverse High
Q9 - 9/16" QS Series	M9 - 9/16" Medium Pressure	H6 - 3/8" High Pressure	P8 - 1/2" NPT	RH14 - 7/8" -14 Reverse High
Q12 - 3/4" QS Series	M12 - 3/4" Medium Pressure	H9 - 9/16" High Pressure	P12 - 3/4" NPT	RH16 - 1" -12 Reverse High
	M16 - 1" Medium Pressure		P16 - 1" NPT	RH21 - 1-5/16" -12 Reverse High

*RH9 & RH14 - 40,000 psi (2758 bar), RH12 - 30,000 psi (2068 bar), RH16 - 26,000 psi (1793 bar), RH21 - 20,000 psi (1379 bar).

QS Series to Reverse High-Pressure Adapters

Catalog Number	Connection QS	Connection RH	Dimension inches (mm)	
			A Hex	B
15MAQ4RH9	QS250	9/16"	0.63 (15.9)	1.70 (43.2)
15MAQ6RH9	QS375	9/16"	0.75 (19.1)	1.81 (46.2)
15MAQ9RH9	QS562	9/16"	1.19 (30.1)	2.25 (57.1)
15MAQ9RH12	QS562	3/4"	1.19 (30.1)	2.38 (60.3)
15MAQ9RH16	QS562	1"	1.19 (30.1)	2.56 (65.1)

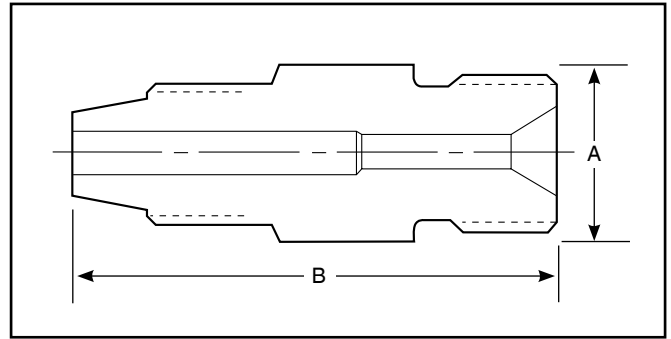

QS Series to High-Pressure Adapter

Catalog Number	Connection QS	Connection H/P	Dimension inches (mm)	
			A Hex	B
15MAQ9H4	QS562	1/4"	0.75 (19.1)	2.00 (50.8)

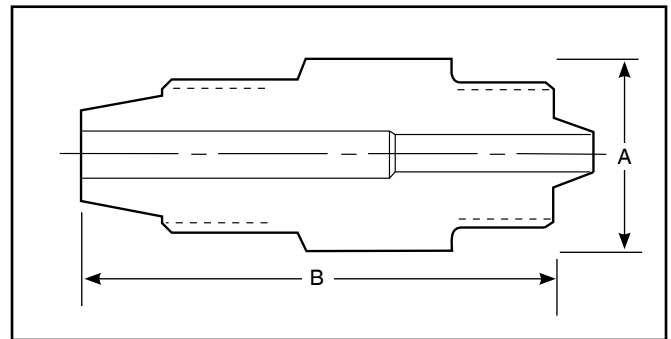

QS Series to NPT Adapter

Catalog Number	Connection QS	Connection NPT	Dimension inches (mm)	
			A Hex	B
15MAQ6P4	QS375	1/4"	0.75 (19.1)	2.00 (50.8)

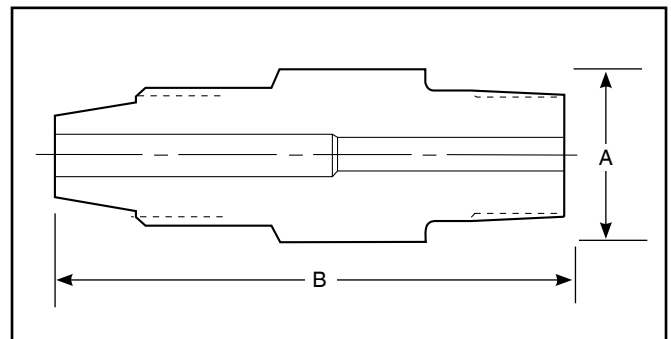

Adapters/Couplings - Male/Male JIC Adapters

Parker Autoclave Engineer's male-to-male JIC one-piece adapters are available in low, medium, and high pressure configurations. JIC adapters are machined from cold worked stainless steel. Other materials are available upon request. Contact your local Sales Representative for optional information. The following tables list our standard adapters with dimensions.



Adapter End Configuration

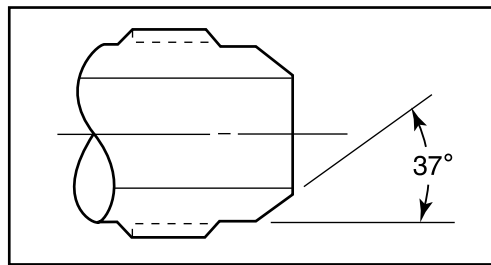

JIC connections consist of a 37° angle.

Ordering Procedure

Typical catalog number: **20 MA M4 J4**

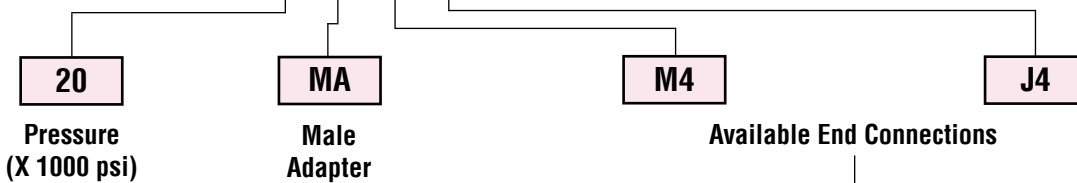

*J4 - 1/4" JIC	L4 - 1/4" Low Pressure	M4 - 1/4" Medium Pressure	H4 - 1/4" High Pressure	P4 - 1/4" NPT
J6 - 3/8" JIC	L6 - 3/8" Low Pressure	M6 - 3/8" Medium Pressure	H6 - 3/8" High Pressure	P6 - 3/8" NPT
J8 - 1/2" JIC	L8 - 1/2" Low Pressure	M9 - 9/16" Medium Pressure	H9 - 9/16" High Pressure	P8 - 1/2" NPT
J10 - 5/8" JIC		M12 - 3/4" Medium Pressure		
J12 - 3/4" JIC		M16 - 1" Medium Pressure		
J16 - 1" JIC				

Note: Special material one piece adapters may be supplied with four flats in place of standard hex.

*J4, J6, J8 & J10 - 20,000 psi (1380 bar), J12 & J16 - 15,000 psi (1034 bar)

Thread Sizes

J4 - 7/16-20
J6 - 9/16-18
J8 - 3/4-16
J10 - 7/8-14
J12 - 1-1/16-12
J16 - 1-5/16-12

Low-Pressure to JIC Adapters

Catalog Number	Connection L/P	Connection JIC	Dimension inches (mm)	
			A Hex	B
15MAL4J4	SW250	1/4"	0.75 (19.1)	1.88 (47.6)
15MAL6J6	SW375	3/8"	0.81 (20.6)	2.00 (50.8)

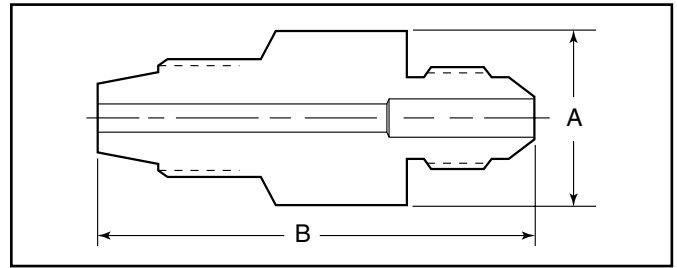

Medium-Pressure to JIC Adapters

Catalog Number	Connection M/P	Connection JIC	Dimension inches (mm)	
			A Hex	B
15MAM4J12	SF250CX	3/4"	1.38 (34.9)	2.25 (57.1)
15MAM4J16	SF250CX	1"	1.50 (38.1)	2.38 (60.3)
15MAM6J12	SF375CX	3/4"	1.38 (34.9)	2.44 (61.3)
15MAM6J16	SF375CX	1"	1.50 (38.1)	2.53 (64.9)
15MAM9J12	SF562CX	3/4"	1.38 (34.9)	2.69 (68.2)
15MAM9J16	SF562CX	1"	1.50 (38.1)	2.78 (70.6)
15MAM12J12	SF750CX	3/4"	1.38 (34.9)	2.88 (73.0)
15MAM12J16	SF750CX	1"	1.50 (38.1)	2.88 (73.0)
15MAM16J12	SF1000CX	3/4"	1.38 (34.9)	3.38 (85.7)
15MAM16J16	SF1000CX	1"	1.50 (38.1)	3.50 (89.0)
20MAM4J4	SF250CX	1/4"	0.75 (19.1)	1.63 (41.3)
20MAM4J6	SF250CX	3/8"	0.81 (20.6)	1.75 (44.5)
20MAM4J8	SF250CX	1/2"	1.00 (25.4)	2.00 (50.8)
20MAM6J4	SF375CX	1/4"	0.75 (19.1)	1.75 (44.5)
20MAM6J6	SF375CX	3/8"	0.81 (20.6)	1.81 (46.0)
20MAM6J8	SF375CX	1/2"	1.00 (25.4)	2.00 (50.8)
20MAM9J4	SF562CX	1/4"	0.94 (23.8)	2.13 (54.0)
20MAM9J6	SF562CX	3/8"	0.94 (23.8)	2.13 (54.0)
20MAM9J8	SF562CX	1/2"	1.00 (25.4)	2.25 (57.1)
20MAM9J10	SF562CX	5/8"	1.19 (30.1)	2.25 (57.1)
20MAM12J4	SF750CX	1/4"	1.19 (30.1)	2.38 (60.3)
20MAM12J6	SF750CX	3/8"	1.19 (30.1)	2.38 (60.3)
20MAM12J8	SF750CX	1/2"	1.19 (30.1)	2.50 (63.5)
20MAM16J4	SF1000CX	1/4"	1.38 (34.9)	3.13 (79.3)
20MAM16J6	SF1000CX	3/8"	1.38 (34.9)	3.13 (79.3)
20MAM16J8	SF1000CX	1/2"	1.38 (34.9)	3.13 (79.3)

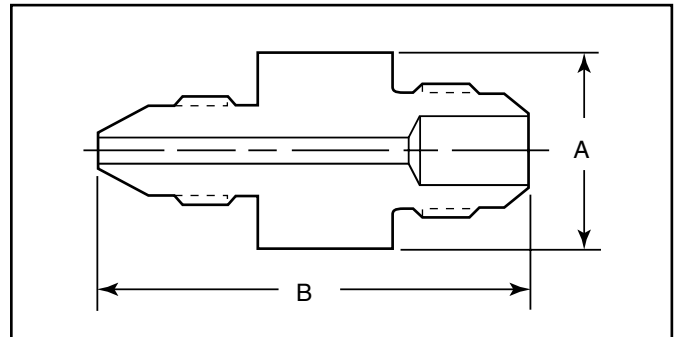

High-Pressure to JIC Adapters

Catalog Number	Connection H/P	Connection JIC	Dimension inches (mm)	
			A Hex	B
20MAH4J2	F250C	1/8"	0.63 (15.9)	1.50 (38.1)
20MAH4J4	F250C	1/4"	0.75 (19.1)	1.63 (41.3)
20MAH4J6	F250C	3/8"	0.81 (20.6)	1.63 (41.3)
20MAH4J8	F250C	1/2"	1.00 (25.4)	1.88 (47.6)
20MAH6J4	F375C	1/4"	0.81 (20.6)	1.94 (49.1)
20MAH6J6	F375C	3/8"	0.81 (20.6)	1.94 (49.1)
20MAH6J8	F375C	1/2"	1.00 (25.4)	2.19 (55.5)
20MAH9J4	F562C	1/4"	1.19 (30.1)	2.31 (58.7)
20MAH9J6	F562C	3/8"	1.19 (30.1)	2.31 (58.7)
20MAH9J8	F562C	1/2"	1.19 (30.1)	2.38 (60.3)
20MAH4J10	F250C	5/8"	1.19 (30.1)	2.13 (54.0)

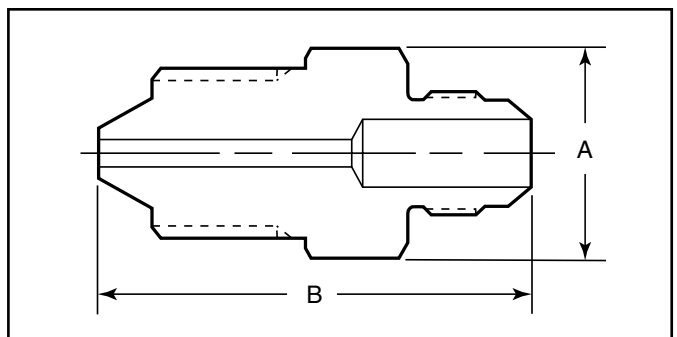

Maximum pressure rating is based on the lowest rating of any component.
Actual working pressure may be determined by tubing pressure rating, if lower.

Note: For pressure rating see ordering procedure.
All Dimensions for reference only and are subject to change.
For prompt service, Parker Autoclave Engineers stocks select products. Consult factory.

JIC to JIC Adapters

Catalog Number	Connection JIC	Connection JIC	Dimension inches (mm)	
			A Hex	B
20MAJ4J4	1/4	1/4"	0.75 (19.1)	1.56 (39.7)
20MAJ6J6	3/8	3/8"	0.81 (20.6)	1.56 (39.7)
20MAJ6J8	3/8	1/2"	1.00 (25.4)	1.75 (44.5)
20MAJ8J8	1/2	1/2"	1.00 (25.4)	1.81 (46.0)

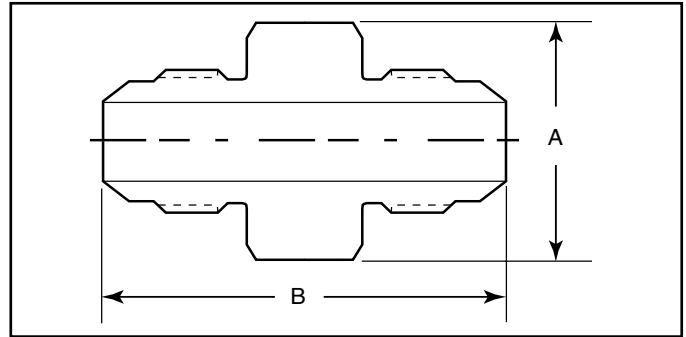

NPT to JIC Adapters

Catalog Number	Connection NPT	Connection JIC	Dimension inches (mm)	
			A Hex	B
15MAP4J4	1/4	1/4"	0.75 (19.1)	1.69 (42.8)
15MAP4J6	1/4	3/8"	0.81 (20.6)	1.75 (44.5)
15MAP4J8	1/4	1/2"	1.00 (25.4)	1.94 (49.1)
15MAP4J12	1/4	3/4"	1.38 (34.9)	2.25 (57.1)
15MAP6J4	3/8	1/4"	0.75 (19.1)	1.69 (42.8)
15MAP6J6	3/8	3/8"	0.81 (20.6)	1.75 (44.5)
15MAP6J8	3/8	1/2"	1.00 (25.4)	1.81 (46.0)
15MAP6J12	3/8	3/4"	1.38 (34.9)	2.25 (57.1)
15MAP8J4	1/2	1/4"	0.94 (23.8)	2.00 (50.8)
15MAP8J8	1/2	1/2"	1.00 (25.4)	2.13 (54.0)
15MAP8J12	1/2	3/4"	1.38 (34.9)	2.44 (61.9)

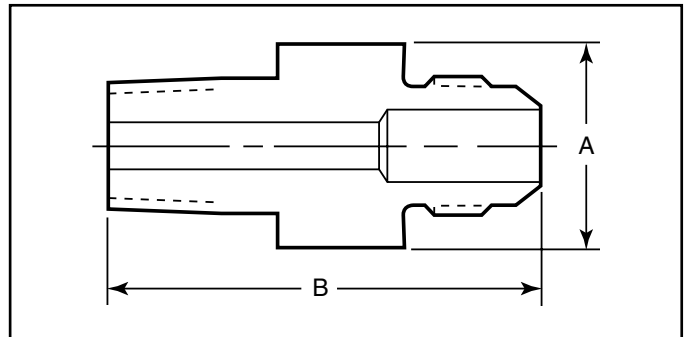

Maximum pressure rating is based on the lowest rating of any component.
Actual working pressure may be determined by tubing pressure rating, if lower.

Note: For pressure rating see ordering procedure.

All Dimensions for reference only and are subject to change.

For prompt service, Parker Autoclave Engineers stocks select products. Consult factory.

NOTE: NPT (Pipe) connections

- NPT threads must be sealed using a high quality PTFE tape and/or PTFE paste product. Refer to thread sealant manufacturer's instructions on how to apply thread sealant.
- Sealing performance may vary based on many factors such as pressure, temperature, media, thread quality, thread material, proper thread engagement and proper use of thread sealant.
- Customer should limit the number of times an NPT fitting is assembled and disassembled because thread deformation during assembly will result in deteriorating seal quality over time. When using only PTFE tape, consider using thread lubrication to prevent galling of mating parts.

Adapters/Couplings - Male/Female JIC Adapters

Male /female adapters are designed to adapt a female connection to another size and/or type of connection without the need for additional couplings. In selecting an adapter involving two different sized connections, the larger connection should be on the male end where it is possible to maximize the mechanical strength of the adapter.

To use this chart:

1. Locate MALE end in vertical column.
2. Locate desired FEMALE end of adapter across top of chart.
3. Catalog number of required adapter is located at intersection of columns.
4. For one piece adapter add-OP to suffix of part number where applicable.

Other Adapters

Parker Autoclave Engineers supplies many other types of adapters on special order. These include Parker Autoclave UniVersa-Lok swaged-type connections, socketweld to O.D. tube or nominal pipe size, male or female AN connections and others.

Materials

All Parker Autoclave Engineers adapters are precision machined from cold-worked Type 316 stainless steel. Other materials available on special order.

Note: Special material couplings may be supplied with four flats in place of standard hex.

		FEMALE END										
		Connection Size and Type		JIC						Medium Pressure		
		Fits this Female Connection	Pressure Rating PSI (bar)*	1/4" JIC4	3/8" JIC6	1/2" JIC8	5/8" JIC10	3/4" JIC12	1" JIC16	1/4" SF250CX	3/8" SF375CX	9/16" SF562CX
				20,000 (1378.93)	20,000 (1378.93)	20,000 (1378.93)	20,000 (1378.93)	15,000 (1034.20)	15,000 (1034.20)	20,000 (1378.93)	20,000 (1378.93)	20,000 (1378.93)
MALE END	JIC	1/4" JIC4	20,000 (1378.93)							20MFAJ4M4	20MFAJ4M6	20MFAJ4M9
		3/8" JIC6	20,000 (1378.93)							20MFAJ6M4	20MFAJ6M6	20MFAJ6M9
		1/2" JIC8	20,000 (1378.93)							20MFAJ8M4	20MFAJ8M6	20MFAJ8M9
		5/8" JIC10	20,000 (1378.93)									
		3/4" JIC12	15,000 (1034.20)							15MFAJ12M4	15MFAJ12M6	15MFAJ12M9
		1" JIC16	15,000 (1034.20)							15MFAJ16M4	15MFAJ16M6	15MFAJ16M9
	Medium Pressure	1/4" SF250CX	20,000 (1378.93)	20MFAM4J4	20MFAM4J6							
		3/8" SF375CX	20,000 (1378.93)									
		9/16" SF562CX	20,000 (1378.93)									
		3/4" SF750CX	20,000 (1378.93)	20MFAM12J4								
		1" SF1000CX	20,000 (1378.93)									
	High Pressure	1/4" F250C	60,000 (4136.85)	20MFAH4J4								
		3/8" F375C	60,000 (4136.85)									
		9/16" F562C	60,000 (4136.85)									
	National Pipe Thread (NPT)	1/4" NPT	15,000 (1034.20)									
		3/8" NPT	15,000 (1034.20)		15MFAP6J6							
		1/2" NPT	15,000 (1034.20)									
		3/4" NPT	10,000 (689.45)									
		1" NPT	10,000 (689.45)									

Note:
All adapters with Parker Autoclave connections are supplied with appropriate glands, collars, tube nuts and sleeves unless specified without.
JIC connections are not supplied with connection components.

* The maximum pressure rating for an adapter is determined by the connection component with the LOWEST pressure rating; that is, the two end connections and the tubing or pipe used, whichever is LOWER.
CAUTION: See appropriate pressure section in reference to proper selection of tubing.

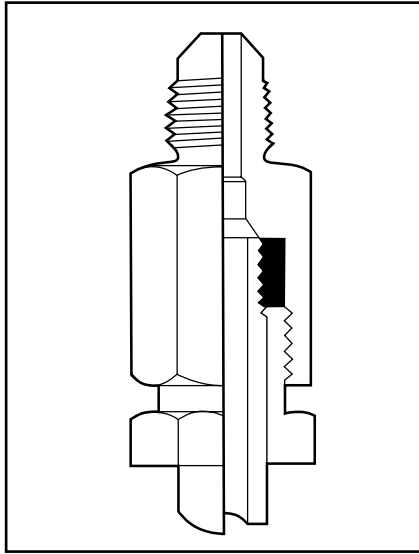

FEMALE END									
Medium Pressure		High Pressure			National Pipe Thread (NPT)				
3/4" F750CX	1" F1000CX	1/4" F250C	3/8" F375C	9/16" F562C	1/4" NPT	3/8" NPT	1/2" NPT	3/4" NPT	1" NPT
20,000 (1378.93)	20,000 (1378.93)	60,000 (4136.85)	60,000 (4136.85)	60,000 (4136.85)	15,000 (1034.20)	15,000 (1034.20)	15,000 (1034.20)	10,000 (689.45)	10,000 (689.45)
20MFAJ4M12	20MFAJ4M16	20MFAJ4H4	20MFAJ4H6	20MFAJ4H9	15MFAJ4P4		15MFAJ4P8		
20MFAJ6M12	20MFAJ6M16		20MFAJ6H6						
20MFAJ8M12	20MFAJ8M16								
15MFAJ12M12	15MFAJ12M16								
15MFAJ16M12	15MFAJ16M16								

Parker AE Male/Female Adapters are available in a "one-piece" design. They are identical to the two piece designs in length and can be ordered by adding the suffix - OP to the two piece adapter part numbers listed.

For prompt service, Parker Autoclave Engineers stocks select products. Consult factory.

Male End Fits this Connection	Female End	Catalog Number	Dimension inches (mm)	
			A Hex	B

JIC to Medium Pressure				
1/4" JIC	SF250CX	20MFAJ4M4	0.63 (15.9)	1.25 (31.8)
1/4" JIC	SF375CX	20MFAJ4M6	0.75 (19.1)	1.50 (38.1)
1/4" JIC	SF562CX	20MFAJ4M9	1.00 (25.4)	1.88 (47.8)
1/4" JIC	SF750CX	20MFAJ4M12	1.38 (35.1)	2.13 (54.0)
1/4" JIC	SF1000CX	20MFAJ4M16	1.75 (44.5)	2.75 (69.9)
3/8" JIC	SF250CX	20MFAJ6M4	0.63 (15.9)	1.25 (31.8)
3/8" JIC	SF375CX	20MFAJ6M6	0.75 (19.1)	1.44 (36.5)
3/8" JIC	SF562CX	20MFAJ6M9	1.00 (25.4)	1.88 (47.8)
3/8" JIC	SF750CX	20MFAJ6M12	1.38 (35.1)	2.13 (54.0)
3/8" JIC	SF1000CX	20MFAJ6M16	1.75 (44.5)	2.62 (66.5)
1/2" JIC	SF250CX	20MFAJ8M4	0.81 (20.6)	1.63 (41.3)
1/2" JIC	SF375CX	20MFAJ8M6	0.81 (20.6)	1.75 (44.5)
1/2" JIC	SF562CX	20MFAJ8M9	1.00 (25.4)	1.88 (47.8)
1/2" JIC	SF750CX	20MFAJ8M12	1.38 (35.1)	2.25 (57.2)
1/2" JIC	SF1000CX	20MFAJ8M16	1.75 (44.5)	2.75 (69.9)
3/4" JIC	SF250CX	15MFAJ12M4	1.38 (35.1)	2.00 (50.8)
3/4" JIC	SF375CX	15MFAJ12M6	1.38 (35.1)	2.00 (50.8)
3/4" JIC	SF562CX	15MFAJ12M9	1.38 (35.1)	2.00 (50.8)
3/4" JIC	SF750CX	15MFAJ12M12	1.38 (35.1)	2.25 (57.2)
3/4" JIC	SF1000CX	15MFAJ12M16	1.75 (44.5)	3.25 (82.6)
1" JIC	SF250CX	15MFAJ16M4	1.50 (38.1)	2.00 (50.8)
1" JIC	SF375CX	15MFAJ16M6	1.50 (38.1)	2.00 (50.8)
1" JIC	SF562CX	15MFAJ16M9	1.50 (38.1)	2.25 (57.2)
1" JIC	SF750CX	15MFAJ16M12	1.38 (35.1)	2.62 (66.5)
1" JIC	SF1000CX	15MFAJ16M16	1.75 (44.5)	3.25 (82.6)
JIC to High Pressure				
1/4" JIC	SF250C	20MFAJ4H4	0.75 (19.1)	1.38 (35.1)
1/4" JIC	SF375C	20MFAJ4H6	1.00 (25.4)	1.50 (38.1)
1/4" JIC	SF562C	20MFAJ4H9	1.38 (35.1)	2.00 (50.8)
3/8" JIC	SF375C	20MFAJ6H6	1.00 (25.4)	1.50 (38.1)
JIC to NPT				
1/4" JIC	1/4" NPT	15MFAJ4P4	0.94 (23.8)	1.50 (38.1)
1/4" JIC	1/2" NPT	15MFAJ4P8	1.19 (30.1)	1.88 (47.8)
Medium Pressure to JIC				
SF250CX	1/4" JIC	20MFAM4J4	0.75 (19.1)	1.56 (39.7)
SF250CX	3/8" JIC	20MFAM4J6	0.81 (20.6)	1.50 (38.1)
SF750CX	1/4" JIC	20MFAJ12J4	1.19 (30.1)	2.00 (50.8)
High Pressure to JIC				
F250C	1/4" JIC	20MFAH4J4	0.75 (19.1)	1.50 (38.1)
NPT to JIC				
3/8" NPT	3/8" JIC	15MFAP6J6	0.81 (20.6)	1.50 (38.1)

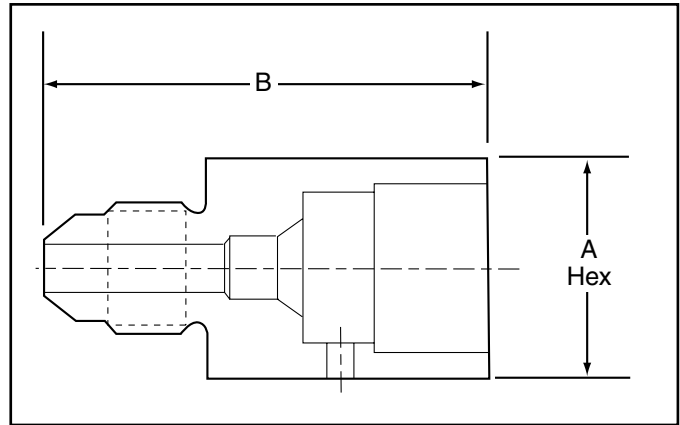

Adapters/Couplings - EZ-Union Adapters

Parker Autoclave Engineers offers an EZ-Union adapter providing a fast and simple way to install or remove components from a pressure system. The face seal o-ring design provides a positive seal with easy and reliable operation. EZ-Union adapters can be provided with any standard or special connection combination. Optional materials available upon request. Contact your local Sales Representative for optional information and sizes not shown. The following tables show the standard adapters with dimensions.



EZ-Union Adapter

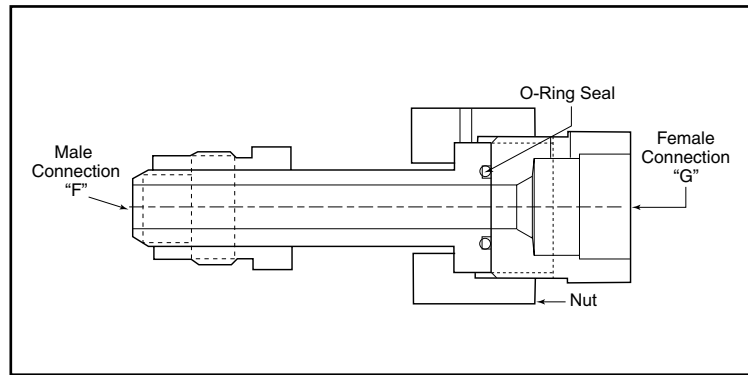

Ordering Procedure

Typical catalog number: 20 EZ M4 M4



For Butt-Weld or specials contact factory.

When ordering Male to Female adapters, Male connection is listed first.

M4 - 1/4" Medium Pressure	H4 - 1/4" High Pressure	P4 - 1/4" NPT
M6 - 3/8" Medium Pressure	H6 - 3/8" High Pressure	P6 - 3/8" NPT
M9 - 9/16" Medium Pressure	H9 - 9/16" High Pressure	P8 - 1/2" NPT
M12 - 3/4" Medium Pressure		P12 - 3/4" NPT
M16 - 1" Medium Pressure		P16 - 1" NPT

Note: Special material EZ-Unions may be supplied with four flats in place of standard hex.

EZ-Union Male to Female Adapters

Catalog Number	Male "F" Connection	Female "G" Connection	Pressure Rating psi (bar)	Dimension inches (mm)				
				A	B	C Hex	D Hex	E Min Opening
20EZM4M4	SM250CX20	SF250CX20	20,000 (1379)	3.13 (79.50)	1.00 (25.40)	1.00 (25.40)	0.81 (20.57)	0.109 (2.77)
10EZM9M9	SM562CX20	SF562CX20	10,000 (690)	4.63 (117.60)	1.63 (41.40)	1.75 (44.45)	1.38 (34.93)	0.31 (7.92)
10EZM12M12	SM750CX20	SF750CX20	10,000 (690)	4.63 (117.60)	1.38 (35.05)	1.75 (44.45)	1.50 (38.10)	0.44 (11.13)
10EZM16M16	SM1000CX20	SF1000CX20	10,000 (690)	6.44 (163.58)	2.31 (58.67)	1.75 (44.45)	1.75 (44.45)	0.56 (14.27)
10EZP12M12	3/4" NPT	SF750CX20	10,000 (690)	4.63 (117.60)	1.38 (35.05)	1.75 (44.45)	1.50 (38.10)	0.44 (11.13)
10EZM16P8	SM1000CX20	1/2" NPT	10,000 (690)	5.38 (136.65)	1.25 (31.75)	1.75 (44.45)	1.38 (35.05)	0.56 (14.27)

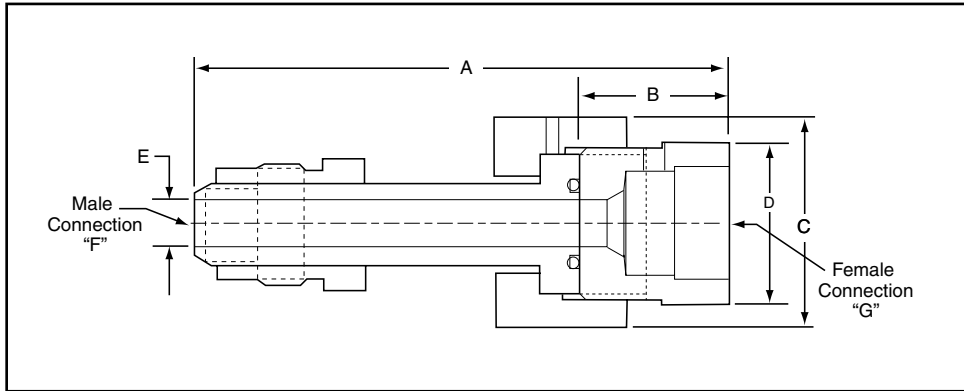

EZ-Union Male to Male Adapters

Catalog Number	Male "F" Connection	Male "G" Connection	Pressure Rating psi (bar)	Dimension inches (mm)				
				A	B	C Hex	D Hex	E Min Opening
20EZMAH4H6	M250C	M375C	20,000 (1379)	5.94 (150.88)	3.56 (90.42)	1.00 (25.40)	0.81 (20.57)	0.09 (2.29)
10EZMAP12M12	SM750CX20	3/4" NPT	10,000 (690)	6.50 (165.10)	3.25 (82.55)	1.75 (44.45)	0.87 (22.05)*	0.44 (11.13)

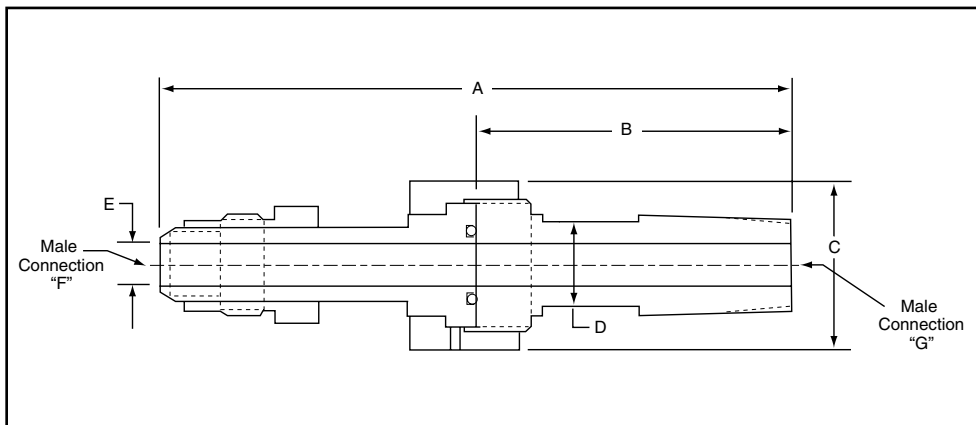

Note 1: EZ-Unions are constructed from 316 SS and are supplied with a Viton o-ring as standard.

*across flats

Note 2: Gland and collar supplied with medium and high pressure connections.

Note: For pressure rating see ordering procedure.
All Dimensions for reference only and subject to change.

Maximum pressure rating is based on the lowest rating of any component.
Actual working pressure may be determined by tubing pressure rating, if lower.

For prompt service, Parker Autoclave Engineers stocks select products. Consult factory.

Adapters/Couplings - Butt-Weld Adapters

Parker Autoclave Engineer's Butt-Weld adapters are available in a number of configurations. The following tables show models for all three pressure ranges. Models not shown and special material adapters are available upon request. Contact your local Sales Representative for more information.



Butt-Weld Adapter

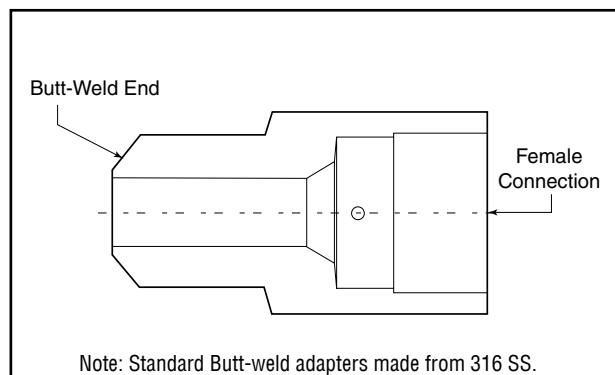

Butt-Weld Adapters

Weld Connection Type	Size/Schedule	AE Low Pressure - Female Connection				
		SW250	SW375	SW500		
Pipe Butt-Weld	3/4" / XXS			M128W2B-XXS		

Weld Connection Type	Size/Schedule	AE Medium Pressure - Female Connection				
		SF250CX	SF375CX	SF562CX	SF750CX	SF1000CX
Pipe Butt-Weld	1/8" / 80	M24W6B-XS	M26W6B-XS			
Pipe Butt-Weld	1/4" / 80	M44W6B-XS	M46W6B-XS	M49W6B-XS		
Pipe Butt-Weld	3/8" / 80	M64W6B-XS	M66W6B-XS	M69W6B-XS	M612W6B-XS	
Pipe Butt-Weld	1/2" / 80	M84W6B-XS		M89W6B-XS		
Pipe Butt-Weld	1/2" / XXS			M89W6B-XXS	M812W6B-XXS	M816W6B-XXS
Pipe Butt-Weld	3/4" / 80			M129W6B-XS		
Pipe Butt-Weld	3/4" / 160			M129W6B-160		
Pipe Butt-Weld	3/4" / XXS			M129W6B-XXS	M1212W6B-XXS	M1216W6B-XXS
Pipe Butt-Weld	1" / XXS					M1616W6B-XXS

Weld Connection Type	Size/Schedule	AE High Pressure - Female Connection				
		F250C	F375C	F562C	F562C40	SF1000CX43
Pipe Butt-Weld	1" / XXS			M169W3B-XXS		

All general terms and conditions of sale, including limitations of our liability, apply to all products and services sold.

Butt-Weld to Low-Pressure

Catalog Number	Male BW	Female LP	Pressure Rating		Dimension inches (mm)		
			psi	bar	A Hex	B	C
M128W2B-XXS	3/4"	SF500	10,000	689.5	1.19 (30.23)	2.00 (50.80)	0.81 (20.57)

Butt-Weld to Medium-Pressure

Catalog Number	Male BW	Female M/P	Pressure Rating		Dimension inches (mm)		
			psi	bar	A Hex	B	C
M24W6B-XS	1/8"	SF250CX	8500	586.0	0.63 (15.88)	1.00 (25.40)	0.38 (9.53)
M26W6B-XS	1/8"	SF375CX	8500	586.0	0.75 (19.05)	1.31 (33.32)	0.38 (9.53)
M44W6B-XS	1/4"	SF250CX	8000	551.6	0.63 (15.88)	1.18 (29.97)	0.56 (14.27)
M46W6B-XS	1/4"	SF375CX	8000	551.6	0.75 (19.05)	1.50 (38.10)	0.56 (14.27)
M49W6B-XS	1/4"	SF562CX	8000	551.6	1.00 (25.40)	1.56 (39.67)	0.56 (14.27)
M64W6B-XS	3/8"	SF250CX	6500	448.2	0.75 (19.05)	1.25 (31.75)	0.63 (15.88)
M66W6B-XS	3/8"	SF375CX	6500	448.2	0.75 (19.05)	1.56 (39.67)	0.63 (15.88)
M69W6B-XS	3/8"	SF562CX	6500	448.2	1.00 (25.40)	1.63 (41.28)	0.63 (15.88)
M612W6B-XS	3/8"	SF750CX	6500	448.2	1.38 (34.93)	1.94 (49.20)	0.63 (15.88)
M84W6B-XS	1/2"	SF250CX	6000	413.7	1.00 (25.40)	1.38 (34.93)	0.81 (20.57)
M86W6B-XXS	1/2"	SF375CX	13000	896.3	1.00 (25.40)	1.75 (44.45)	0.81 (20.57)
M89W6B-XS	1/2"	SF375CX	6000	413.7	1.00 (25.40)	1.81 (45.97)	0.81 (20.57)
M89W6B-XXS	1/2"	SF562CX	10000	689.5	1.00 (25.40)	1.81 (45.97)	0.81 (20.57)
M812W6B-XXS	1/2"	SF750CX	10000	689.5	1.38 (34.93)	2.13 (53.98)	0.81 (20.57)
M816W6B-XXS	1/2"	SF1000CX	10000	689.5	1.75 (44.45)	2.81 (71.37)	0.81 (20.57)
M129W6B-XS	3/4"	SF562CX	5000	344.7	1.19 (30.23)	1.81 (45.97)	0.81 (20.57)
M129W6B-160	3/4"	SF562CX	7500	517.1	1.19 (30.23)	2.00 (50.80)	0.81 (20.57)
M129W6B-XXS	3/4"	SF562CX	10000	689.5	1.19 (30.23)	2.00 (50.80)	0.81 (20.57)
M1212W6B-XXS	3/4"	SF750CX	10000	689.5	1.38 (34.93)	2.06 (52.32)	0.81 (20.57)
M1216W6B-XXS	3/4"	SF1000CX	10000	689.5	1.75 (44.45)	2.69 (68.25)	0.81 (20.57)
M1616W6B-XXS	1"	SF1000CX	10000	689.5	1.75 (44.45)	3.25 (82.55)	1.31 (33.32)

Butt-Weld to High-Pressure

Catalog Number	Male BW	Female LP	Pressure Rating		Dimension inches (mm)		
			psi	bar	A Hex	B	C
M169W3B-XXS	1"	F562C	10000	689.5	1.38 (34.93)	2.44 (61.90)	1.22 (30.99)

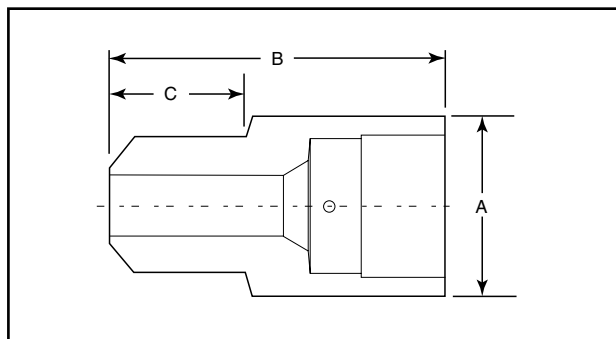

Gland and collar supplied with high pressure connections.

Maximum pressure rating is based on the lowest rating of any component.
Actual working pressure may be determined by piping pressure rating, contact factory.

Note: For pressure rating see ordering procedure.
All Dimensions for reference only and are subject to change.
For prompt service, Parker Autoclave Engineers stocks select products. Consult factory.

Adapters/Couplings - Header Couplings

Parker Autoclave Engineer's offers weld style Header Couplings in a number of designs and materials. The standard materials are SAE-4130 and Inconel 625. Other materials are listed in the tables. Header couplings are available drilled through or blind drilled, allowing final drill through after welding. The couplings can be supplied with any style of Parker Autoclave Engineers connection or special connections if required. Header couplings come standard with 316 SS glands and collars for our medium and high-pressure connections. Models not shown are available upon request. Contact your local sales representative.



Header Coupling

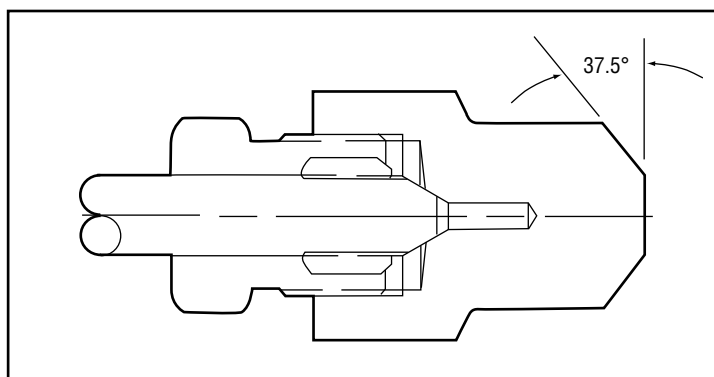

Ordering Procedure

Typical catalog number: **HC F M16 W 625 DT**

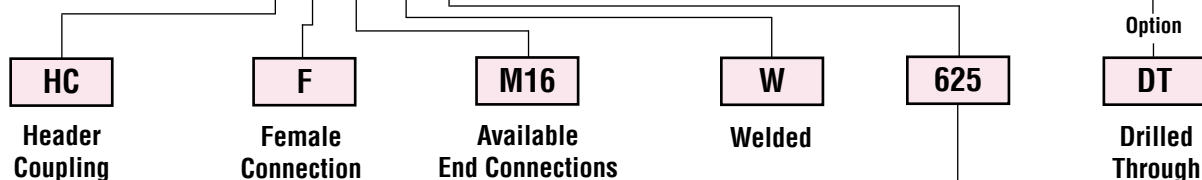

SAE 4130 - 4130
Inconel 625 - 625
2205 Duplex - 2205
316 SS - 316
A105 - 105
A105N - 105 Normalized

M4 - 1/4" Medium Pressure M6 - 3/8" Medium Pressure M9 - 9/16" Medium Pressure M12 - 3/4" Medium Pressure M16 - 1" Medium Pressure	H4 - 1/4" High Pressure H6 - 3/8" High Pressure H9 - 9/16" High Pressure	P4 - 1/4" NPT P6 - 3/8" NPT P8 - 1/2" NPT P12 - 3/4" NPT P16 - 1" NPT
---	---	--

Female Medium-Pressure Header Coupling Blind End

Catalog Number	Material	Pressure psi (bar)	Female M/P	Dimension inches (mm)				
				A Flats	B	C	D	E
HCFM12W316	316 SS	10,000 (690)	SF750CX20	1.75 (44.45)	3.00 (76.2)	1.05 (26.7)	1.32 (33.5)	0.44 (11.2)
HCFM12W105	SA-105	10,000 (690)	SF750CX20	1.75 (44.45)	3.00 (76.2)	1.05 (26.7)	1.32 (33.5)	0.44 (11.2)
HCFM12W4130	SAE-4130	20,000 (1379)	SF750CX20	1.75 (44.45)	3.00 (76.2)	1.05 (26.7)	1.32 (33.5)	0.44 (11.2)
HCFM12W2205	2205 Duplex	15,000 (1034)	SF750CX20	1.75 (44.45)	3.00 (76.2)	1.05 (26.7)	1.32 (33.5)	0.44 (11.2)
HCFM16W316	316 SS	10,000 (690)	SF1000CX20	1.75 (44.45)	2.62 (66.55)	1.00 (25.40)	1.38 (34.93)	0.56 (14.27)
HCFM16W2205	2205 Duplex	15,000 (1034)	SF1000CX20	1.75 (44.45)	3.00 (76.2)	1.05 (26.7)	1.31 (33.27)	0.56 (14.27)

Female High-Pressure Header Coupling Blind End

Catalog Number	Material	Pressure psi (bar)	Female H/P	Dimension inches (mm)				
				A Flats	B	C	D	E
HCFH9W316	316SS	30,000 (2068)	F562C	1.50 (38.10)	2.31 (58.67)	1.19 (30.18)	1.31 (33.27)	0.19 (4.75)
HCFH9W4130	SAE-4130	30,000 (2068)	F562C	1.50 (38.10)	2.31 (58.67)	1.19 (30.18)	1.31 (33.27)	0.19 (4.75)
HCFH9W625	Inconel 625	30,000 (2068)	F562C	1.50 (38.10)	2.31 (58.67)	1.19 (30.18)	1.31 (33.27)	0.19 (4.75)
HCFH16W4130	SAE-4130	20,000 (1379)	F1000C43	1.75 (44.45)	3.00 (76.20)	1.05 (26.59)	1.32 (33.53)	0.44 (11.10)
HCFH16W625	Inconel 625	22,000 (1551)	F1000C43	1.75 (44.45)	3.00 (76.20)	1.05 (26.59)	1.32 (33.53)	0.44 (11.10)

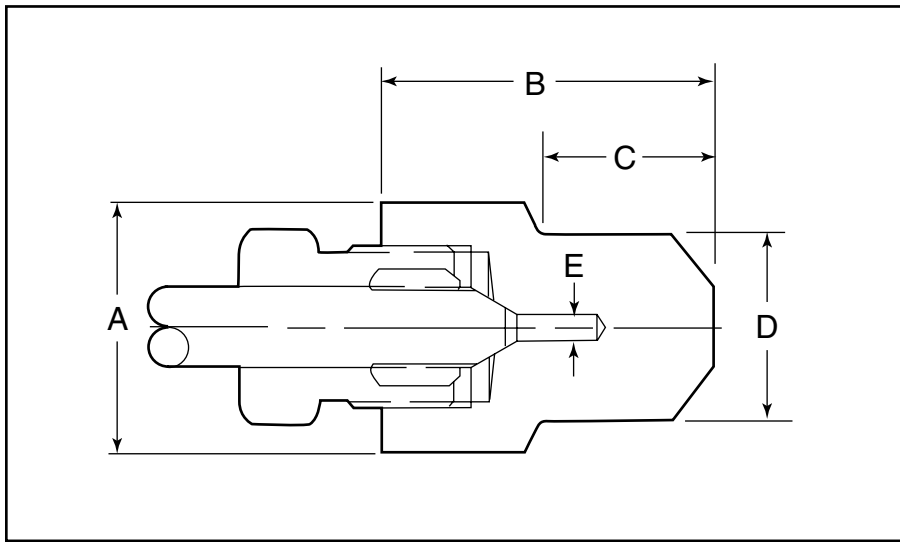

Gland and collar supplied with high pressure connections.

Maximum pressure rating is based on the lowest rating of any component.
Actual working pressure may be determined by tubing pressure rating, if lower.

All Dimensions for reference only and are subject to change.

For prompt service, Parker Autoclave Engineers stocks select products. Consult factory.

Female Medium-Pressure Header Coupling Drill Through

Catalog Number	Material	Pressure psi (bar)	Female M/P	Dimension inches (mm)				
				A Flats	B	C	D	E
HCFM4W316DT	316 SS	10,000 (690)	SF250CX20	0.63 (16.0)*	1.19 (30.2)	0.56 (14.3)	0.54 (13.6)	0.11 (2.8)
HCFM9W316DT	316 SS	10,000 (690)	SF562CX20	1.38 (35.1)*	2.44 (62.0)	1.13 (28.6)	1.32 (33.5)	0.36 (9.1)
HCFM9W4130DT	SAE-4130	25,000 (1724)	SF562CX20	1.38 (35.1)	2.44 (62.0)	1.13 (28.6)	1.32 (33.5)	0.36 (9.1)
HCFM12W4130DT	SAE-4130	20,000 (1379)	SF750CX	1.38 (35.1)	2.63 (66.68)	1.05 (26.7)	1.32 (33.5)	0.44 (11.2)
HCFM12W2205DT	2205 duplex	15,000 (1034)	SF750CX20	1.75 (44.45)	3.00 (76.20)	1.05 (26.7)	1.32 (33.5)	0.44 (11.2)
HCFM16W316DT	316 SS	10,000 (690)	SF1000CX20	1.75 (44.45)	3.00 (76.20)	1.05 (26.7)	1.32 (33.5)	0.56 (14.2)
HCFM16W316LDT	316L SS	10,000 (690)	SF1000CX20	1.75 (44.45)	3.00 (76.20)	1.05 (26.7)	1.32 (33.5)	0.56 (14.2)
HCFM16W4130DT	SAE-4130	20,000 (1379)	SF1000CX20	1.75 (44.45)	3.00 (76.20)	1.05 (26.7)	1.32 (33.5)	0.56 (14.2)
HCFM16W105DT	SA-105	12,000 (827)	SF1000CX20	1.75 (44.45)	3.00 (76.20)	1.05 (26.7)	1.32 (33.5)	0.56 (14.2)
HCFM16W2205DT	2205 duplex	15,000 (1034)	SF1000CX20	1.75 (44.45)	3.00 (76.20)	1.05 (26.7)	1.32 (33.5)	0.56 (14.2)
HCFM16W625DT	Inconel 625	15,000 (1034)	SF1000CX20	1.75 (44.45)	3.00 (76.20)	1.05 (26.7)	1.32 (33.5)	0.56 (14.2)

*across hex

Female High-Pressure Header Coupling Drill Through

Catalog Number	Material	Pressure psi (bar)	Female H/P	Dimension inches (mm)				
				A Flats	B	C	D	E
HCFH9W316DT	316SS	30,000 (2068)	F562C	1.50 (38.10)	2.31 (58.67)	1.19 (30.18)	1.31 (33.27)	0.19 (4.75)
HCFH9W4130DT	SAE-4130	30,000 (2068)	F562C	1.50 (38.10)	2.31 (58.67)	1.19 (30.18)	1.31 (33.27)	0.19 (4.75)
HCFH9W625DT	Inconel 625	30,000 (2068)	F562C	1.50 (38.10)	2.31 (58.67)	1.19 (30.18)	1.31 (33.27)	0.19 (4.75)
HCFH16W4130DT	SAE-4130	20,000 (1379)	F1000C43	1.75 (44.45)	3.00 (76.20)	1.05 (26.59)	1.32 (33.53)	0.44 (11.10)
HCFH16W625DT	Inconel 625	22,000 (1551)	F1000C43	1.75 (44.45)	3.00 (76.20)	1.05 (26.59)	1.32 (33.53)	0.44 (11.10)

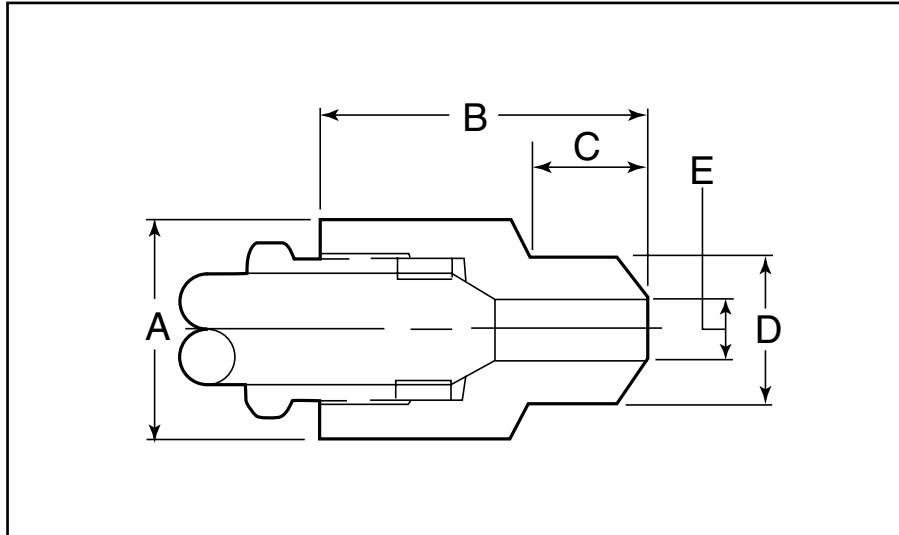

Gland and collar supplied with high pressure adapters.

Maximum pressure rating is based on the lowest rating of any component.
Actual working pressure may be determined by tubing pressure rating, if lower.

Note: For pressure rating see ordering procedure.

All Dimensions for reference only and are subject to change.

For prompt service, Parker Autoclave Engineers stocks select products. Consult factory.

Adapters/Couplings - Bulkhead Adapters

Parker Autoclave Engineers bulkhead adapters are used to connect tubing or piping of different sizes and configurations through the panel. Bulkhead adapters are machined from cold worked stainless steel. Other material and connections are available. Contact your local Sales Representative for optional information.



Bulkhead Adapter

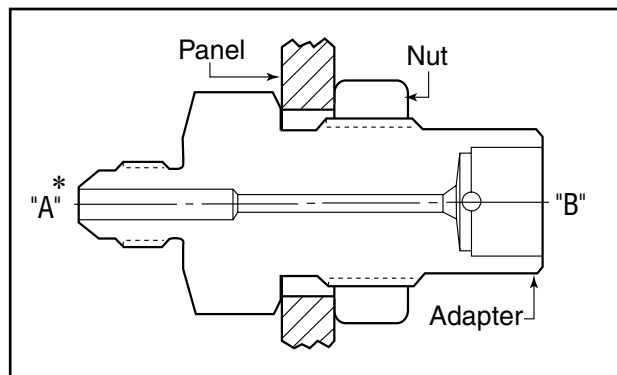

Ordering Procedure

Typical catalog number: 20 BA M J16* F H4

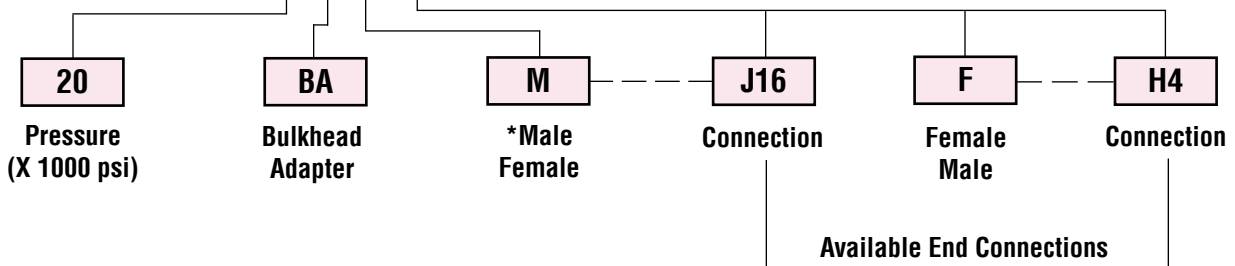

*Note: First connection designation is "A" side.

J4 - 1/4" JIC	L4 - 1/4" Low Pressure	M4 - 1/4" Medium Pressure	H4 - 1/4" High Pressure	P4 - 1/4" NPT
J6 - 3/8" JIC	L6 - 3/8" Low Pressure	M6 - 3/8" Medium Pressure	H6 - 3/8" High Pressure	P6 - 3/8" NPT
J8 - 1/2" JIC	L8 - 1/2" Low Pressure	M9 - 9/16" Medium Pressure	H9 - 9/16" High Pressure	P8 - 1/2" NPT
J10 - 5/8" JIC		M12 - 3/4" Medium Pressure	RH9 - 9/16" Reverse High Pressure	
J12 - 3/4" JIC		M16 - 1" Medium Pressure	RH12 - 3/4" Reverse High Pressure	
J16 - 1" JIC			RH16 - 1" Reverse High Pressure	

Note: Special material adapters may be supplied with four flats in place of standard hex.

Reverse High to Medium-Pressure

Male Connection R/H	AE Medium Pressure - Female Connection				
	SF250CX	SF375CX	SF562CX	SF750CX	SF1000CX
9/16"	20BAMRH9FM4	20BAMRH9FM6	20BAMRH9FM9		
3/4"			20BAMRH12FM9		20BAMRH12FM16
1"					20BAMRH16FM16

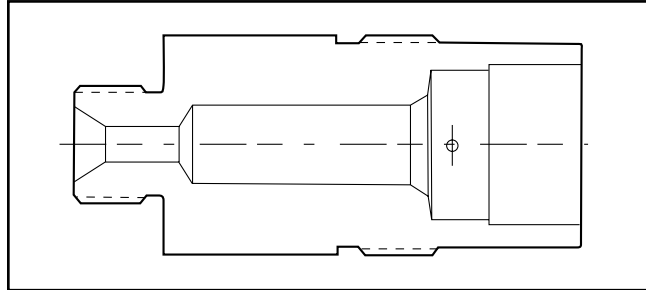

Reverse High to High Pressure

Male Connection R/H	AE High Pressure - Female Connection				
	F250C	F375C	F562C		
9/16"	40BAMRH9FH4		40BAMRH9FH9		
3/4"			30BAMRH12FH9		
1"					

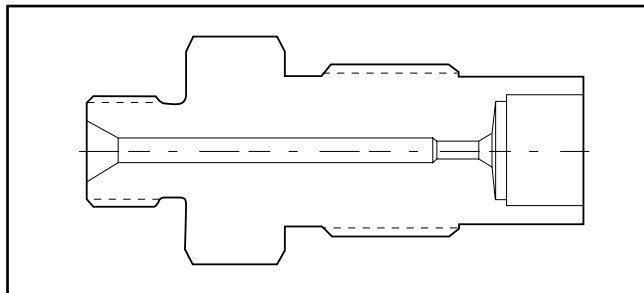

NPT to Medium Pressure

Male Connection NPT	AE Medium Pressure - Female Connection				
	SF250CX	SF375CX	SF562CX	SF750CX	SF1000CX
1/4"	15BAMP4FM4	15BAMP4FM6			
3/8"		15BAMP6FM6			
1"					

Gland and collar supplied with adapter.

Maximum pressure rating is based on the lowest rating of any component. Actual working pressure may be determined by tubing pressure rating, if lower.

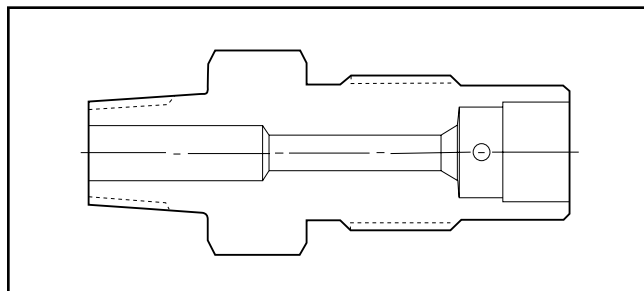

Note: For pressure rating see ordering procedure. All Dimensions for reference only and are subject to change.

For prompt service, Parker Autoclave Engineers stocks select products. Consult factory.

JIC to Low Pressure

Male Connection JIC	AE Low Pressure - Female Connection				
	SW250	SW375	SW500		
1/4"	15BAMJ4FL4				
3/8"					
1/2"					

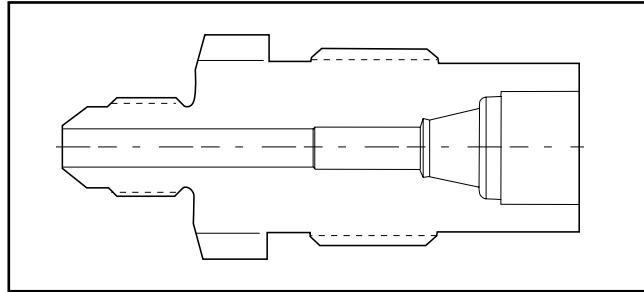

JIC to Medium Pressure

Male Connection JIC	AE Medium Pressure - Female Connection				
	SF250CX	SF375CX	SF562CX	SF750CX	SF1000CX
1/4"	20BAMJ4FM4	20BAMJ4FM6		20BAMJ4FM12	
3/8"	20BAMJ6FM4	20BAMJ6FM6	20BAMJ6FM9	20BAMJ6FM12	
1/2"		20BAMJ8FM6	20BAMJ8FM9	20BAMJ8FM12	20BAMJ8FM16

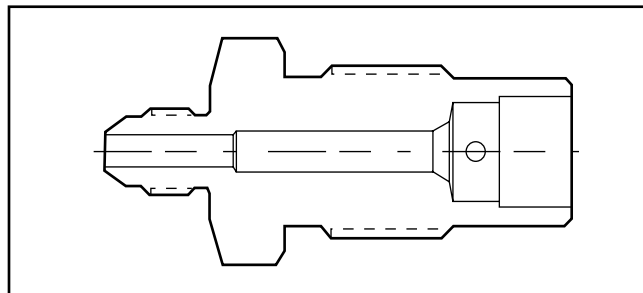

JIC to High Pressure

Male Connection JIC	AE High Pressure - Female Connection				
	F250C	F375C	F562C		
1/4"	20BAMJ4FH4				
3/8"	20BAMJ6H4				
1/2"					

Gland and collar supplied with adapter.

Maximum pressure rating is based on the lowest rating of any component. Actual working pressure may be determined by tubing pressure rating, if lower.

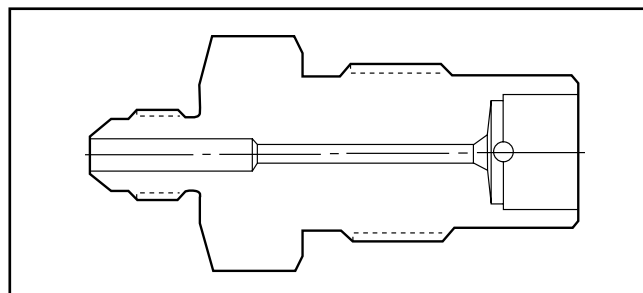

Note: For pressure rating see ordering procedure. All Dimensions for reference only and are subject to change.

For prompt service, Parker Autoclave Engineers stocks select products. Consult factory.

Reverse High Pressure to Medium Pressure

Catalog Number	Male R/H	Female M/P	Dimension inches (mm)				
			A Panel Hole	B	C	D Max	E Hex
20BAMRH9FM4	9/16"	SF250CX	0.81 (20.62)	2.56 (65.0)	1.22 (31.0)	0.38 (9.65)	1.00 (25.40)
20BAMRH9FM6	9/16"	SF375CX	0.94 (23.88)	2.63 (66.80)	1.13 (28.70)	0.38 (9.65)	1.00 (25.40)
20BAMRH9FM9	9/16"	SF562CX	1.13 (28.58)	3.00 (76.20)	1.28 (32.51)	0.38 (9.65)	1.38 (34.93)
20BAMRH12FM9	3/4"	SF562CX	1.13 (28.58)	3.13 (79.50)	1.41 (35.81)	0.38 (9.65)	1.38 (34.93)
20BAMRH12FM16	3/4"	SF1000CX	1.94 (49.28)	4.26 (108.20)	2.13 (54.10)	0.38 (9.65)	2.13 (54.10)
20BAMRH16FM16	1"	SF1000CX	1.94 (49.28)	4.41 (112.01)	2.28 (57.91)	0.38 (9.65)	2.13 (54.10)

Reverse High Pressure to High Pressure

Catalog Number	Male R/H	Female H/P	Dimension inches (mm)				
			A Panel Hole	B	C	D Max	E Hex
40BAMRH9FH4	9/16"	F250C	0.94 (23.88)	2.50 (63.50)	1.00 (25.40)	0.38 (9.65)	1.00 (25.40)
40BAMRH9FH9	9/16"	F562C	1.69 (42.85)	3.38 (85.85)	1.50 (38.10)	0.38 (9.65)	1.88 (47.75)
30BAMRH12FH9	3/4"	F562C	1.69 (42.85)	3.50 (88.90)	1.62 (41.15)	0.38 (9.65)	1.88 (47.75)

Pipe to Medium Pressure

Catalog Number	Male NPT	Female M/P	Dimension inches (mm)				
			A Panel Hole	B	C	D Max	E Hex
15BAMP4FM4	1/4"	SF250CX	0.81 (20.62)	2.56 (65.02)	1.22 (31.01)	0.38 (9.65)	1.00 (25.40)
15BAMP4FM6	1/4"	SF375CX	0.94 (23.88)	2.69 (68.33)	1.31 (33.35)	0.38 (9.65)	1.00 (25.40)
15BAMP6FM6	3/8"	SF375CX	0.94 (23.88)	2.75 (69.85)	1.25 (31.75)	0.38 (9.65)	1.00 (25.40)

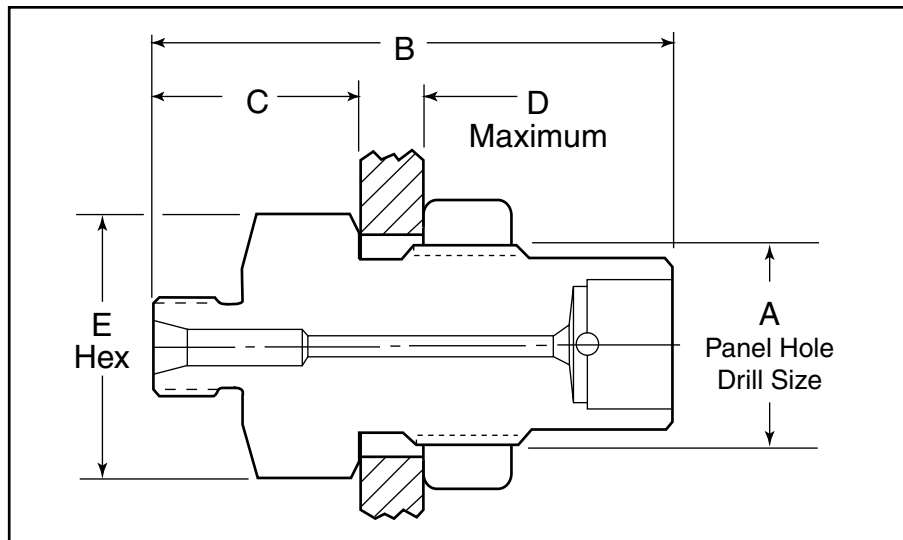

Gland and collar supplied with adapter.

Maximum pressure rating is based on the lowest rating of any component.
Actual working pressure may be determined by tubing pressure rating, if lower.

Note: For pressure rating see ordering procedure.
All Dimensions for reference only and are subject to change.

For prompt service, Parker Autoclave Engineers stocks select products. Consult factory.

JIC to Low Pressure

Catalog Number	Male JIC	Female LP	Dimension inches (mm)				
			A Panel Hole	B	C	D Max	E Hex
15BAMJ4FL4	1/4"	SW250	0.94 (23.88)	2.29 (58.04)	0.91 (23.11)	0.38 (9.65)	1.00 (25.40)

JIC to Medium Pressure

Catalog Number	Male JIC	Female MP	Dimension inches (mm)				
			A Panel Hole	B	C	D Max	E Hex
20BAMJ4FM4	1/4"	SF250CX	0.81 (20.62)	2.25 (57.15)	0.91 (23.11)	0.38 (9.65)	1.00 (25.40)
20BAMJ4FM6	1/4"	SF375CX	0.81 (20.62)	2.44 (61.93)	0.94 (23.88)	0.38 (9.65)	1.00 (25.40)
20BAMJ4FM12	1/4"	SF750CX	1.69 (42.85)	2.94 (74.68)	1.22 (31.0)	0.38 (9.65)	1.88 (47.75)
20BAMJ6FM4	3/8"	SF250CX	0.81 (20.62)	2.25 (57.15)	0.91 (23.11)	0.38 (9.65)	1.00 (25.40)
20BAMJ6FM6	3/8"	SF375CX	0.94 (23.88)	2.44 (61.98)	0.94 (23.88)	0.38 (9.65)	1.00 (25.40)
20BAMJ6FM9	3/8"	SF562CX	1.13 (28.58)	2.75 (69.85)	1.16 (29.46)	0.38 (9.65)	1.38 (34.93)
20BAMJ6FM12	3/8"	SF750CX	1.69 (42.85)	2.94 (74.68)	1.22 (31.0)	0.38 (9.65)	1.88 (47.75)
20BAMJ8FM6	1/2"	SF375CX	0.81 (20.62)	2.53 (64.26)	1.03 (26.16)	0.38 (9.65)	1.00 (25.40)
20BAMJ8FM9	1/2"	SF562CX	1.13 (28.58)	3.00 (76.20)	1.41 (35.69)	0.38 (9.65)	1.38 (34.93)
20BAMJ8FM12	1/2"	SF750CX	1.69 (42.85)	3.13 (79.38)	1.41 (35.69)	0.38 (9.65)	1.88 (47.75)
20BAMJ8FM16	1/2"	SF1000CX	1.94 (49.20)	4.36 (110.72)	2.23 (56.62)	0.50 (12.70)	1.87 (47.50*)

*Dimension across flats

JIC to High Pressure

Catalog Number	Male JIC	Female HP	Dimension inches (mm)				
			A Panel Hole	B	C	D Max	E Hex
20BAMJ4FH4	1/4"	F250C	0.94 (23.80)	2.44 (61.90)	1.06 (26.97)	0.38 (9.65)	1.00 (25.40)
20BAMJ6FH4	3/8"	F250C	0.94 (23.80)	2.47 (62.74)	1.09 (27.79)	0.38 (9.65)	1.00 (25.40)

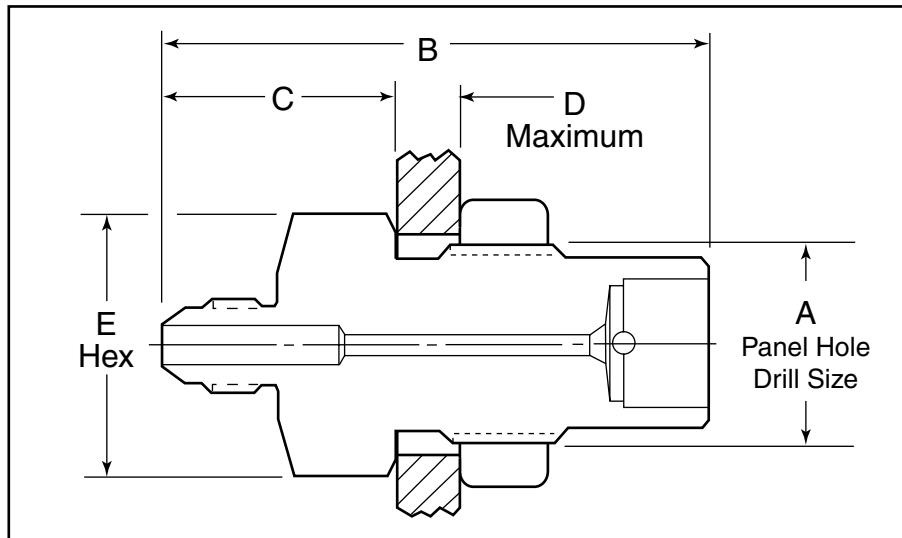

Gland and collar supplied with adapter.

Maximum pressure rating is based on the lowest rating of any component.
Actual working pressure may be determined by tubing pressure rating, if lower.

Note: For pressure rating see ordering procedure.
All Dimensions for reference only and are subject to change.

For prompt service, Parker Autoclave Engineers stocks select products. Consult factory.

Adapters/Couplings - SAE O-Ring Adapters

Parker Autoclave Engineers also offers a line of components that assist in adapting into and out of specialized connections with Parker Autoclave Engineers products. Along with the adapters shown, Parker Autoclave Engineers can provide other special adapters to fill your requirements. Contact your local Sales representative for information.

AE Low, Medium and High Medium Pressure (Female) SAE/MS Male

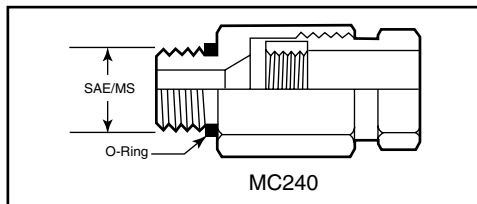

MC240 (SAE/MS Straight thread Boss)

Note: O-rings are standard Buna-N.
10,000 psi (690 bar) operating pressure.

Connection Type	SAE/MS Thread Size (inches)	AE Low Pressure (Female)			
		W125	SW250	SW 375	SW500
MC240 (SAE/MS)	5/16-24				
	7/16-20		M44MC2B	M46MC2B	
	9/16-18				
	3/4-16				

Connection Type	SAE/MS Thread Size (inches)	AE Medium Pressure (Female)				
		SF250CX	SF375CX	SF562CX	SF750CX	SF1000CX
MC240 (SAE/MS)	5/16-24	M24MC6B	M26MC6B			
	7/16-20	M44MC6B	M46MC6B	M49MC6B		
	9/16-18	M64MC6B	M66MC6B	M69MC6B		
	3/4-16		M86MC6B	M89MC6B	M812MC6B	
	7/8-14				M1012MC6B	M1016MC6B
	1-1/16-12		M126MC6B		M1212MC6B	M1216MC6B
	1-5/16-12					M1616MC6B

Connection Type	SAE/MS Thread Size (inches)	AE High Pressure (Female)			
		F250C	F375C	F562C	
MC240 (SAE/MS)	5/16-24				
	7/16-20	M44MC3B	M46MC3B		
	9/16-18	M64MC3B	M66MC3B		
	3/4-16				

For additional information contact your local sales representative.

Adapters/Couplings - Female Tube Caps / Gauge Connectors

Tube Caps

Parker Autoclave Engineers offers a line of tube caps used to seal the ends of tubing. Caps are used when pressure testing lengths of tubes or capping off sections of systems for isolation or pressure tests.



Female Tube Caps - Low Pressure

Catalog Number	Connection Type	Outside Diameter Tube-Inches	Pressure Rating psi (bar)*	Dimension inches (mm)	
				A Hex	B
SWTC2	W125	1/8	15000 (1034.20)	0.50 (12.7)	0.63 (15.9)
SWTC4	SW250	1/4	15000 (1034.20)	0.63 (15.9)	1.00 (25.4)
SWTC6	SW375	3/8	15000 (1034.20)	0.75 (19.1)	1.09 (27.8)
SWTC8	SW500	1/2	10000 (689.5)	1.00 (25.4)	1.25 (31.8)

Female Tube Caps - Medium Pressure

Catalog Number	Connection Type	Outside Diameter Tube-Inches	Pressure Rating psi (bar)*	Dimension inches (mm)	
				A Hex	B
20TC4X	SF250CX	1/4	20000 (1378.9)	0.63 (15.9)	0.81 (20.6)
20TC6X	SF375CX	3/8	20000 (1378.9)	0.75 (19.1)	1.13 (28.6)
20TC9X	SF562CX	9/16	20000 (1378.9)	1.00 (25.4)	1.38 (34.9)
20TC12X	SF750CX	3/4	20000 (1378.9)	1.38 (34.9)	1.75 (44.5)
20TC16X	SF1000CX	1	20000 (1378.9)	1.75 (44.5)	2.25 (57.1)
15TC24X	SF1500CX	1-1/2	15000 (1034.2)	2.25 (57.6)	3.00 (76.2)

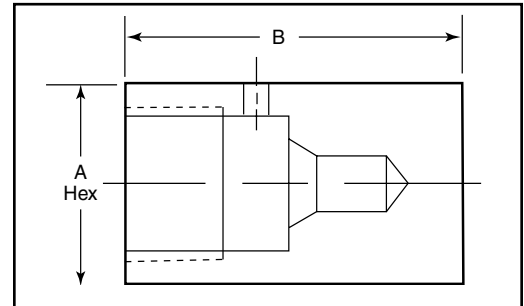

Tube cap configuration may vary from outline shown.

Female Tube Caps - High Pressure Tube Caps

Catalog Number	Connection Type	Outside Diameter Tube-Inches	Pressure Rating psi (bar)*	Dimension inches (mm)	
				A Hex	B
43TC16	F1000C	1	43000 (2964.7)	1.75 (44.5)	2.25 (57.1)
60TC4C	F250C	1/4	60000 (4136.7)	0.75 (19.1)	0.75 (19.1)
60TC6C	F375C	3/8	60000 (4136.7)	1.00 (25.4)	1.13 (28.6)
60TC9C	F562C	9/16	60000 (4136.7)	2.25 (57.1)	1.38 (34.9)
150TC5C	F312C-150	5/16	150,000 (10342)	1.19 (30.1)	2.63 (66.8)

*Maximum pressure rating is based on the lowest rating of any component. Actual working pressure may be determined by tubing pressure rating, if lower. Note: All tube caps are furnished with connection components unless otherwise specified. All dimensions for reference only and subject to change.

For prompt service, Parker Autoclave Engineers stocks select products. Consult factory.

Female Tube Caps - JIC

Catalog Number	Connection Type	Outside Diameter Tube-Inches	Pressure Rating psi (bar)	Dimension inches (mm)	
				A Hex	B
20JC4	JIC	1/4	20000 (1378.9)	0.75 (19.1)	1.00 (25.4)
20JC6	JIC	3/8	20000 (1378.9)	0.94 (23.8)	1.13 (28.6)
20JC8	JIC	1/2	20000 (1378.9)	1.19 (30.1)	1.31 (58.6)

* Maximum pressure rating must not exceed rating of tubing used.

Note: All tube caps are furnished with connection components unless otherwise specified.

All dimensions for reference only and subject to change.

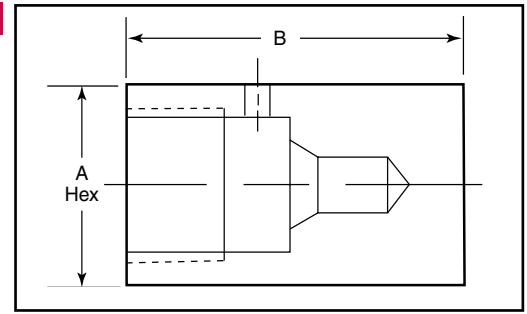

Tube cap configuration may vary from outline shown.

Female Tube Caps and Plugs - Reverse High Pressure (M Style)

Catalog Number	Connection Type	Outside Diameter Tube-Inches	Pressure Rating psi (bar)	Dimension inches (mm)	
				A Hex	B
26RHC16	RHP Cap	1	26000 (1792.6)	1.38 (34.9)	1.13 (28.6)
26RHP16	RHP Plug	1	26000 (1792.6)	---	---

Both caps and plug required.

Gauge Connectors

Parker Autoclave Engineers offers a line of gauge connectors used to connect pressure lines to pressure gauges. Gauge connectors can be connected to gauges with tapered and straight pipe threads, or high-pressure connections.



Gauge Connectors

To Fit This Gauge Connection			1/4" NPT	1/2" NPT	1/2" NPS
Seal Type			Tube Cone	Tube Cone	Gasket
With This Female Tubing Connection			60,000 PSI (4136.8 bar)	60,000 PSI (4136.8 bar)	60,000 PSI (4136.8 bar)
High Pressure	1/4"	F250C	CG4400	CG4800	CG8400
	9/16"	F562C		CG9800	CG8900

Gauge Connectors

To Fit This Gauge Connection			1/4" High Pressure F250C
Seal Type			H.P. Cone
With This Male Tubing Connection			20,000 PSI (1378.9 bar)
Medium Pressure	9/16"	SF562CX	101F-1707

NPT: National Pipe Thread
NPS: National Straight Pipe Thread

Note: For gauge connector without collars and glands, add the following suffix: **-WO**
For gauge connector for sour gas applications, add the following suffix: **-SOG or -SOGWO**

Gauge Connectors

Catalog Number	Gauge Connection Type	Outside Diameter Tube-Inches	Pressure Rating psi (bar)	Dimension inches (mm)		
				A Hex	B	
CG4400	Tube Cone	1/4	60000 (4136.7)	1.00 (25.4)	.813 (20.6)	See Figure 1
CG4800	Tube Cone	1/4	60000 (4136.7)	1.19 (30.1)	.94 (23.8)	
CG9800	Tube Cone	9/16	60000 (4136.7)	1.50 (38.1)	1.25 (31.8)	
CG8400	Gasket	1/4	60000 (4136.7)	1.19 (30.1)	1.19 (30.1)	See Figure 2
CG8900	Gasket	9/16	60000 (4136.7)	1.38 (34.9)	2.25 (57.1)	
101F-1707	1/4" High Pressure	9/16	20000 (1379)	0.63 (15.9)	2.75 (69.9)	See Figure 3

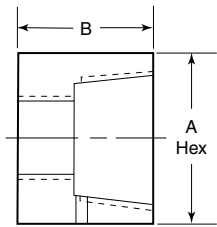

Figure 1
See note 2

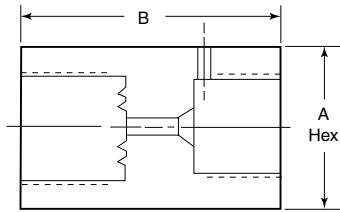

Figure 2

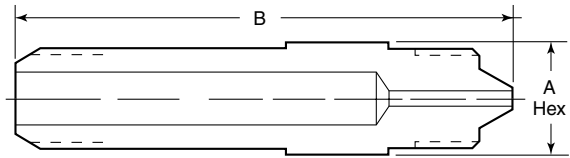

Figure 3

*Maximum pressure rating is based on the lowest rating of any component. Actual working pressure may be determined by tubing pressure rating, if lower.

Note: 1) For pressure rating see selection chart. These adapters are not intended as couplings.

2) Operation of this connector will depend on the inlet hole configuration in the gauge. Check to see that tubing will seal.

For prompt service, Parker Autoclave Engineers stocks select products. Consult factory.

WARNING

FAILURE, IMPROPER SELECTION OR IMPROPER USE OF THE PRODUCTS AND/OR SYSTEMS DESCRIBED HEREIN OR RELATED ITEMS CAN CAUSE DEATH, PERSONAL INJURY AND PROPERTY DAMAGE.

This document and other information from Parker Hannifin Corporation, its subsidiaries and authorized distributors provide product and/or system options for further investigation by users having technical expertise. It is important that you analyze all aspects of your application and review the information concerning the product or system in the current product catalog. Due to the variety of operating conditions and applications for these products or systems, the user, through its own analysis and testing, is solely responsible for making the final selection of the products and systems and assuring that all performance, safety and warning requirements of the application are met. The products described herein, including without limitation, product features, specifications, designs, availability and pricing, are subject to change by Parker Hannifin Corporation and its subsidiaries at any time without notice.

Offer of Sale

The items described in this document are available for sale by Parker Hannifin Corporation, its subsidiaries or its authorized distributors. Any sale contract entered by Parker will be governed by the provisions stated in Parker's standard terms and conditions of sale (copy available upon request).

© 2013 Parker Hannifin Corporation | Autoclave Engineers is a registered trademark of the Parker Hannifin Corporation

02-0127SE January 2013



Instrumentation Products Division
Autoclave Engineers Operation
8325 Hessinger Drive
Erie, Pennsylvania 16509-4679 USA
PH: 814-860-5700 FAX: 814-860-5811
www.autoclave.com

Parker Hannifin Manufacturing Ltd.
Instrumentation Products Division, Europe
Industrial Estate Whitemill
Wexford, Republic of Ireland
PH: 353 53 914 1566
FAX: 353 53 914 1582

Caution! Do not mix or interchange parts or tubing with those of other manufacturers. Doing so is unsafe and will void warranty.

Caution! Parker Autoclave Engineers Valves, Fittings and Tools are not designed to work with common commercial instrument tubing and will only work with tubing built to Parker Autoclave Engineers AES Specifications. Failure to do so will void warranty.

ISO-9001 Certified